

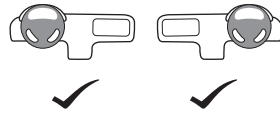

KIA Optima Wagon 2017-
KIA Optima PHEV 2018-

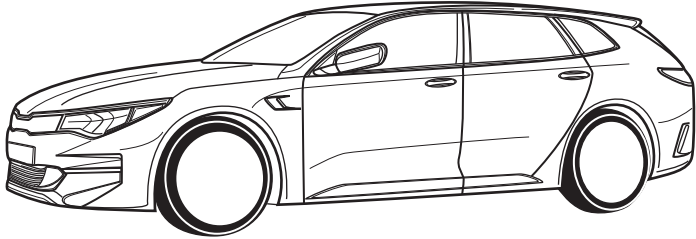

www.mobisparts.eu



D4621ADE11CP

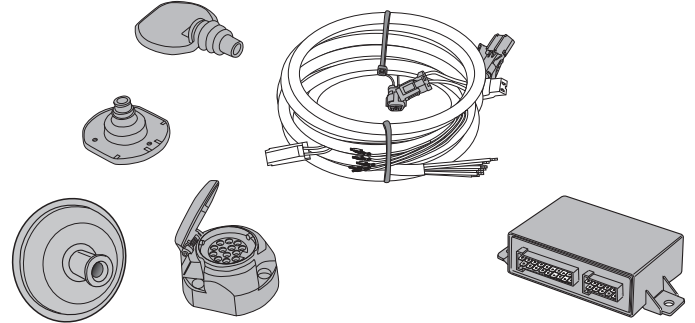

P2/ 17

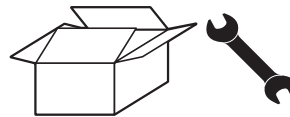

P3/ 17



Fig 1 - 23



1.0hr

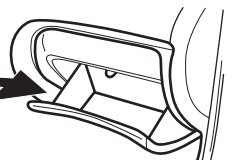
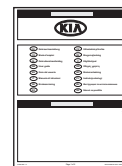



D	Beachten Sie bitte, dass bei Schäden in Folge unsachgemäßen Einbaus sämtliche Garantieansprüche erlöschen.	Das Recht zu Änderungen an Inhalt von Montagesatz und Einbauanleitung ohne Vorankündigung bleibt vorbehalten. Lesen Sie vor dem Einbau diese Anleitung sorgfältig durch.
F	Nous tenons à insister tout particulièrement sur le fait que si ce produit n'est pas correctement assemblé par un technicien compétent, aucun droit de compensation ne sera recevable en cas de dommages, notamment les droits en vertu de la loi concernant la responsabilité à l'égard des produits.	Le contenu de ce produit, ainsi que des guides de montage qui les accompagnent est sujet à modifications sans préavis; lisez attentivement ces instructions avant de procéder à l'installation.
NL	De installatie moet worden uitgevoerd door een erkende, competente installateur. Incorrecte montage kan leiden tot het vervallen van elk recht op schadecompensatie, met name die met betrekking tot product aansprakelijkheid.	De inhoud van deze kits en de installatiehandleidingen kunnen worden gewijzigd zonder kennisgeving. Zorg er voor, dat u deze instructies hebt gelezen en volledig begriipt voordat u met de installatie begint.
GB	We expressly point out that assembly not carried out properly by a competent installer will result in cancellation of any right to damage compensation, in particular those arising by virtue of the product liability act.	Contents of these kits and their fitting manuals are subject to alteration without notice, please ensure that these instructions are read and fully understood before commencing installation.
E	Una vez más, hacemos hincapié en el hecho de que si este producto no es instalado correctamente por un técnico cualificado, se anulará cualquier derecho de compensación por posibles daños, especialmente los relativos a la legislación vigente sobre este tipo de productos.	El contenido de los kits y sus correspondientes manuales de montaje están sujetos a posibles modificaciones sin previo aviso. Es importante que lea con atención todas las instrucciones y que las entienda perfectamente antes de iniciar la instalación.
I	Vi informiamo che, in caso di installazione scorretta e/o non eseguita da un installatore competente, il Cliente perderà ogni diritto a un eventuale rimborso danni e, specificamente, ogni diritto previsto dalle leggi sulla responsabilità di prodotto.	I contenuti di questi kit e i relativi manuali di installazione sono soggetti a modifica senza preavviso. Si raccomanda di leggere attentamente e integralmente tali istruzioni e di sincerarsi di averle comprese prima di procedere all'installazione.
S	Vi meddelar att montering, som inte görs fackmannamässigt, kommer att häva rätten till kompensation för skador, speciellt rättigheter enligt lagen om produktansvar.	Innehållet i dessa satser och deras bruksanvisningar kan komma att ändras utan förvarning. Vänligen läs dessa anvisningar noga innan du påbörjar monteringen.
CZ	Upozorňujeme, že instalace provedená nesprávně nebo nekompetentní osobou, ruší veškerá práva na kompenzaci škod, obzvláště těch způsobených poruchou produktu.	Obsah těchto sad a návody na jejich montáž podléhají změnám bez předchozího upozornění. Prosím, ujistěte se, že jste si pokyny před instalací přečetly a dostatečně jim rozumíte.
DK	Det skal understreges, at montering, der udføres af en ikke-kvalificeret montør, medfører bortfald af enhver ret til erstatning særligt i forbindelse med erstatnings-krav, der måtte opstå i kraft af loven om produktansvar.	Sættenes indhold og monteringsvejledninger kan ændres uden varsel, og vejledningerne skal derfor læses og forstås, før monteringen påbegyndes.
FIN	Jos asennuksen suorittaa joku muu kuin pätevä ammattilainen, tämä kumoo asiakkaan oikeuden vahingonkorvauksiin, erityisesti sellaisiin, jotka perustuvat tuotevastuulakiin.	Kiiinnitysarjan sisältöä ja asennusohjeita voidaan muuttaa siitä etukäteen ilmoittamatta. Näihin ohjeisiin tulee perehtyä huolellisesti ennen asennuksen aloittamista.
GR	Θα πρέπει να τονιστεί ότι συναρμολόγηση που δεν πραγματοποιείται σωστά και από ειδικευμένο εγκαταστάτη οδηγεί σε ακύρωση των όποιων δικαιωμάτων αποζημίωσης έναντι ζημίας και ιδιαίτερα αυτών που προκύπτουν σύμφωνα με το νόμο περί ευθύνης προϊόντος.	Τα περιεχόμενα αυτών των κιτ και τα εγχειρίδια τοποθέτησης υπόκεινται σε αλλαγές χωρίς προειδοποίηση. Βεβαιωθείτε ότι οι οδηγίες αυτές έχουν διαβαστεί και έχουν γίνει απολύτως κατανοητές προτού ξεκινήσετε την εγκατάσταση.
N	Vi bemerker at montasje som ikke utføres korrekt, av en kompetent installatør, vil resultere i annullering av all rett til erstatning for enhver skade, spesielt de som oppstår av arten produktansvar.	Innholdene i disse sett og deres monteringsanvisninger kan endres uten forvarsel. Vennligst påse at disse instruksjonene leses grundig og er forstått innen installasjonen startes.
PL	Pragniemy wyrażnie podkreślić, że nieprawidłowy montaż przeprowadzony przez niekompetentne osoby będzie podstawą rezygnacji z ewentualnego prawa do odszkodowania, w szczególności wynikających z mocy ustawy o odpowiedzialności za produkt.	Zawartość opisywanych zestawów i instrukcje ich montażu mogą ulec zmianie bez uprzedzenia; przed rozpoczęciem instalacji należy zapoznać się z instrukcjami i upewnić się, że zostały w pełni zrozumiałe.
RUS	Обратите внимание, что при повреждениях, возникших в результате неправильного монтажа, истекают все виды гарантии, в частности, касающиеся закона, регулирующего ответственность за качество продукции.	Производитель сохраняет за собой право на изменение содержания монтажного комплекта и инструкции по установке без предварительного уведомления. Внимательно прочитайте инструкцию перед началом установки.
SK	Upozorňujeme, že inštalácia vykonaná nesprávne alebo nekompetentnou osobou, ruší všetky práva na kompenzáciu škod, obzvlášť tých spôsobených poruchou produktu.	Obsah týchto sad a návody na ich montáž podliehajú zmenám bez predchádzajúceho upozornenia. Prosím, uistite sa, že ste si pokyny pred inštaláciou prečítali a dostatočne ste im porozumeli.
RO	Vă atragem atenția că montajul efectuat incorect sau de către personal neautorizat duce la anularea oricărui drept de compensare a eventualelor daune produse utilizatorului.	Conținutul acestor pachete precum și al instrucțiunilor de montaj pot fi modificate fără preaviz. Vă rugăm să vă asigurați că aceste instrucțiuni sunt citite și înțelese înainte de a începe instalarea.

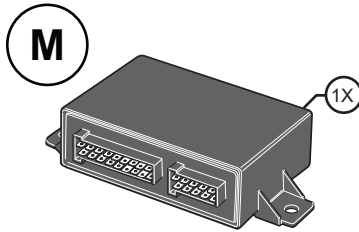
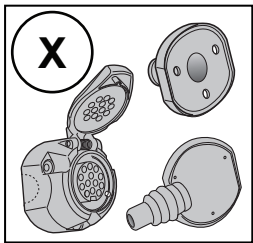
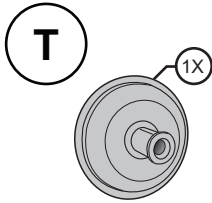
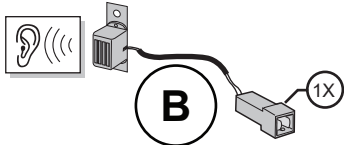
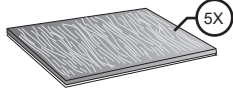
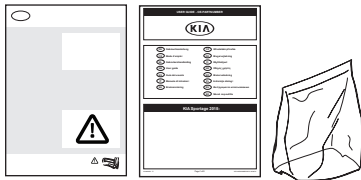
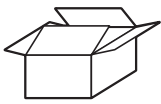
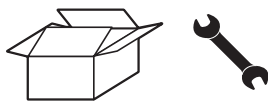

OPTION *+15

*** OPTION +15**

vorbereitung für
 préparation pour
 voorbereiding voor
 preparation for
 preparación para
 förberedelse för
 příprava pro
 forberedelse for
 valmistelu varten
 Προετοιμασία για
 forberedelse på
 przygotowanie do



Option! **P**

Pag. 14 - 16

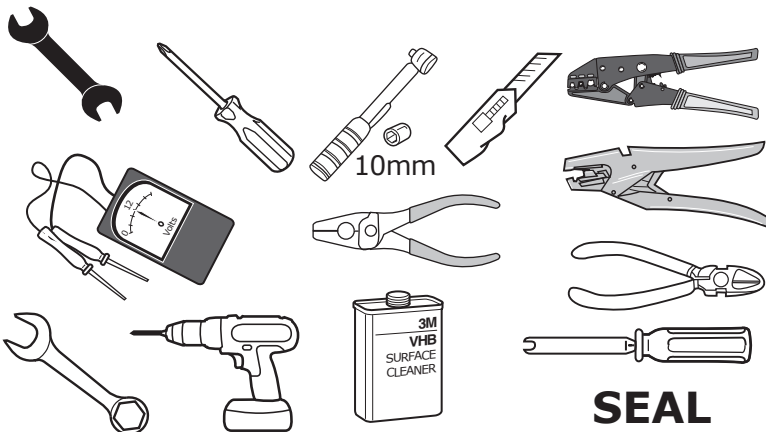
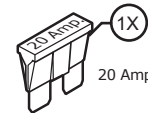
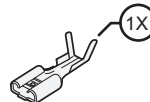
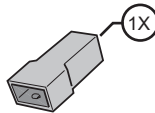
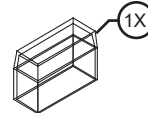
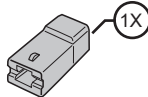
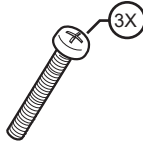

SEAL

Replace

GSW
Global Service Way



	BK	BN	BU	GY	GN	WH	YE	OG	PE	PI	RD
DE	Schwarz	Braun	Blau	Grau	Grün	Weiß	Gelb	Orange	Violett	Rosa	Rot
FR	Noir	Marron	Blue	Gris	Vert	Blanc	Jaune	Orange	Violet	Rose	Rouge
NL	Zwart	Bruin	Blauw	Grijs	Groen	Wit	Geel	Oranje	Paars	Roze	Rood
GB	Black	Brown	Blue	Grey	Green	White	Yellow	Orange	Purple	Pink	Red
ES	Negro	Marrón	Azul	Gris	Verde	Blanco	Amarillo	Naranja	Morado	Rosa	Rojo
IT	Nero	Marrone	Blu	Grigio	Verde	Bianco	Giallo	Arancione	Viola	Rosa	Rosso
SE	Svart	Brun	Blå	Grå	Grön	Vit	Gul	Orange	Lila	Rosa	Röd
CZ	Černá	Hnědá	Modrá	Šedá	Zelená	Bílá	Žlutá	Oranžová	Fialová	Růžová	Červená
DK	Sort	Brun	Blå	Grå	Grøn	Hvid	Gul	Orange	Lilla	Pink	Rød
FI	Musta	Ruskea	Sininen	Harmaa	Vihreä	Valkoinen	Keltainen	Oranssi	Purppura	Vaaleanpunainen	Punainen
GR	Μαύρο	Καφέ	Μπλε	Γκρι	Πράσινο	Λευκό	Κίτρινο	Πορτοκαλί	Μοβ	Ροζ	Κόκκινο
NO	Svart	Brun	Blå	Grå	Grønn	Hvit	Gul	Oransje	Lilla	Rosa	Rød
PL	Czarny	Brązowy	Niebieski	Szary	Zielony	Biały	Żółty	Pomarańczowy	Purpurowy	Różowy	Czerwony
RU	черный	Сірна	синий	серый	зеленый	белый	желтый	оранжевый	пурпурный	розовый	красный
SK	Čierna	Čierna	modrá	Sivá	Zelená	Biela	Žltá	Oranžová	Fialová	Ružová	Červená
RO	Negru	Maro	Albastru	Grey	Verde	Alb	Galben	Portocale	Violet	Roz	Roșu

COLOURTABLE

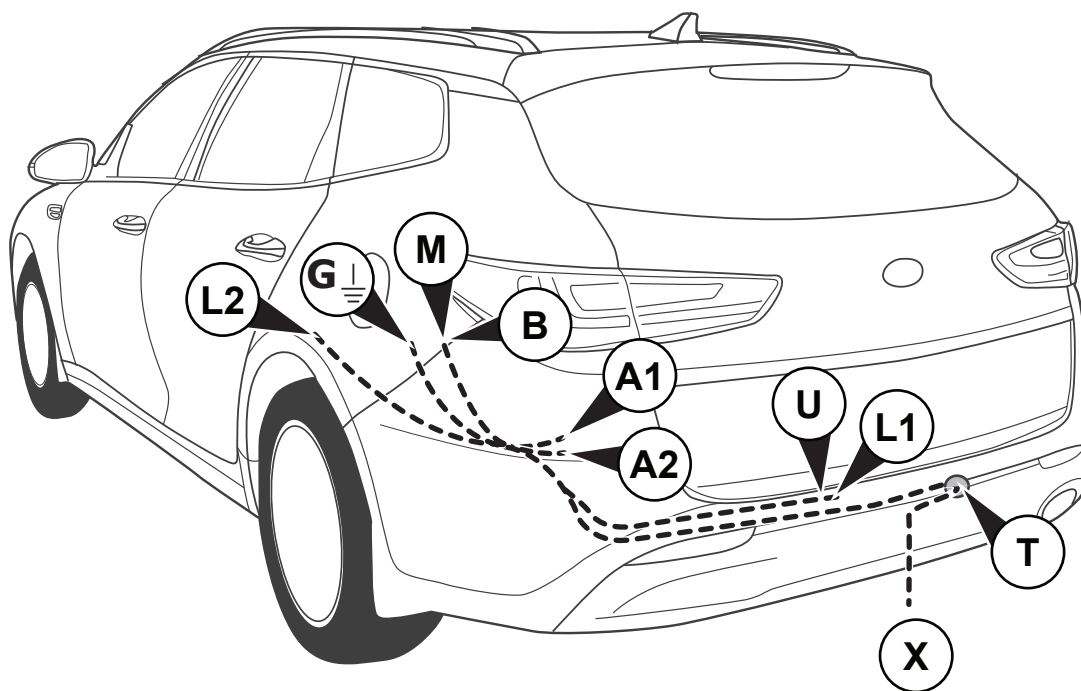

ROUTING

$\geq 18^{\circ} - 40^{\circ}\text{C}$
 $\geq 65^{\circ} - 104^{\circ}\text{F}$

Fig 1

Code

Fig 2

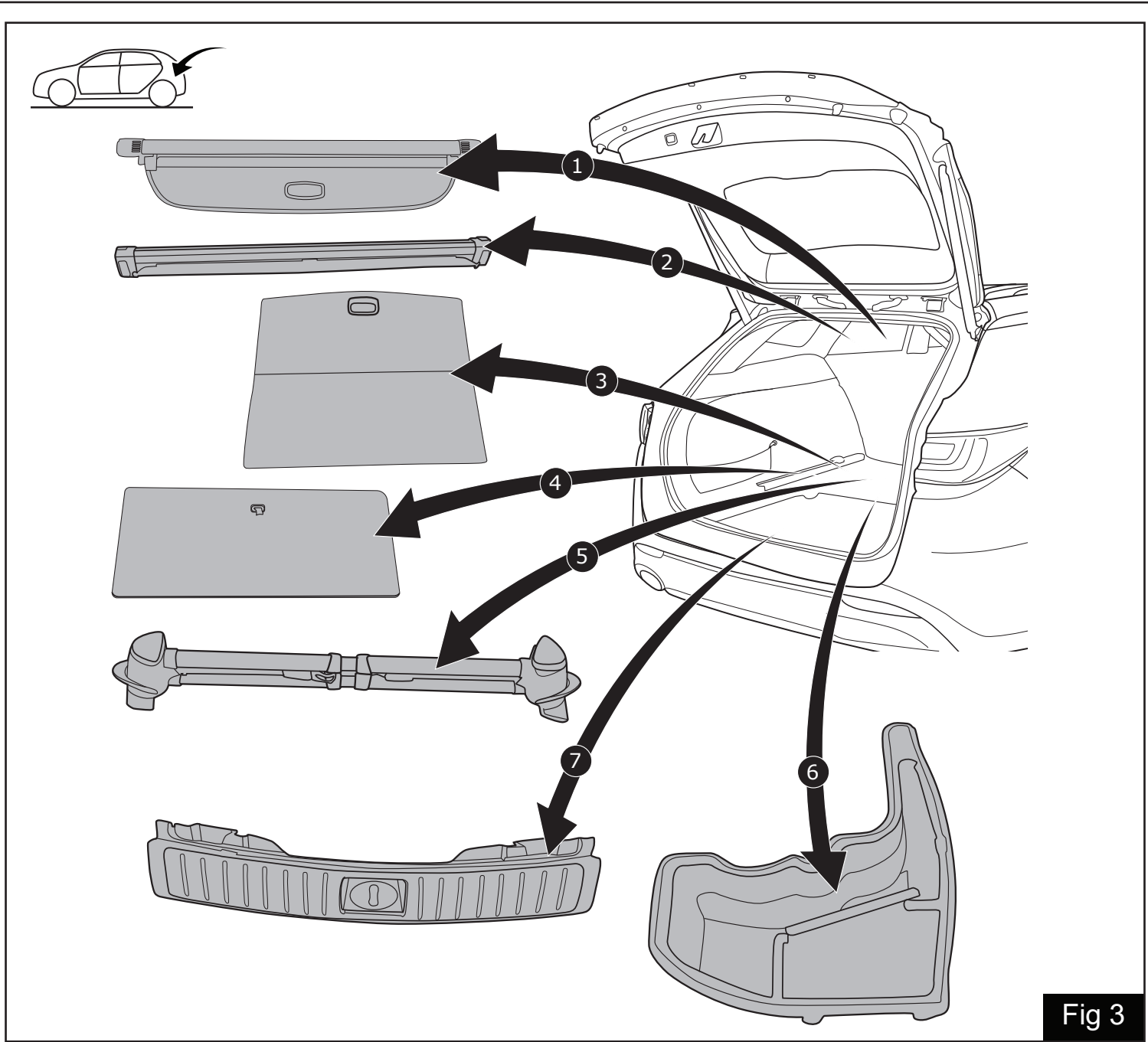

Fig 3

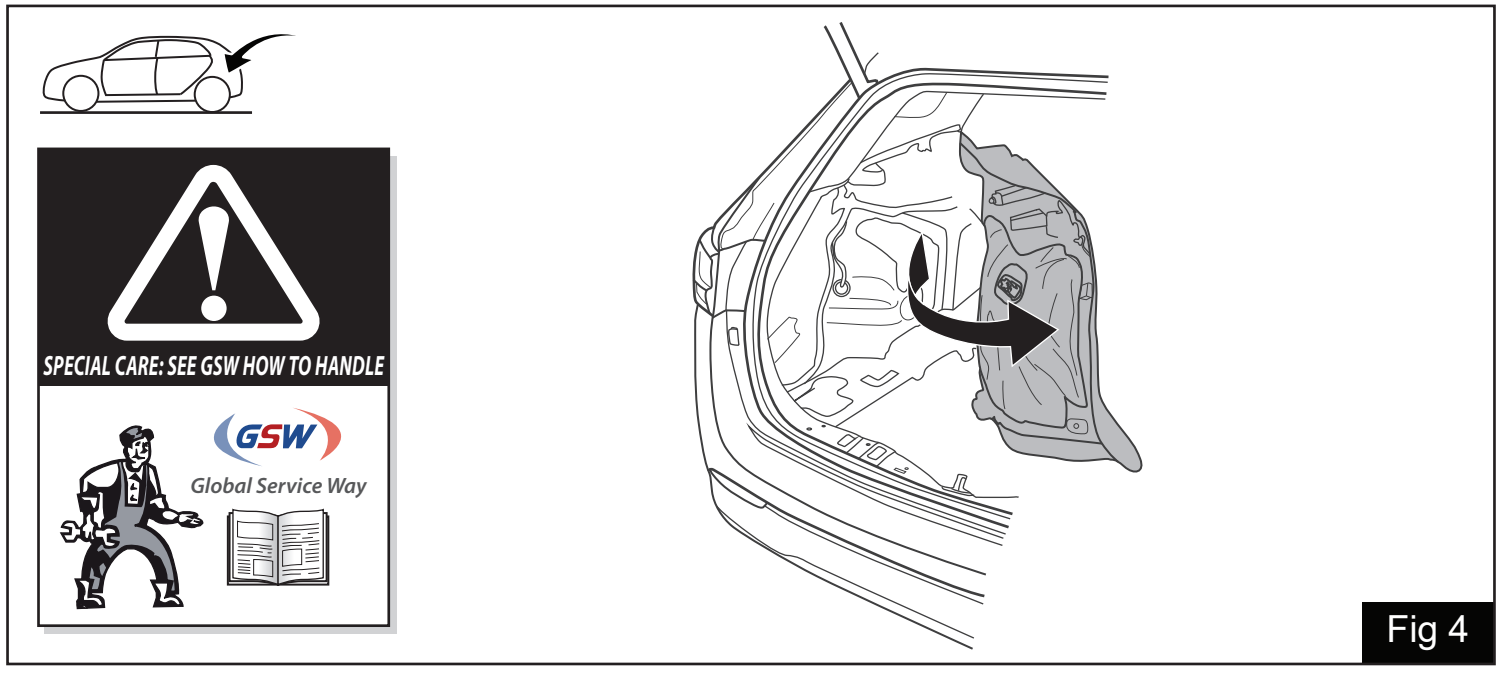
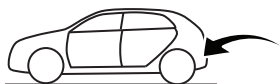

Fig 4



Option 1: - 2017 models

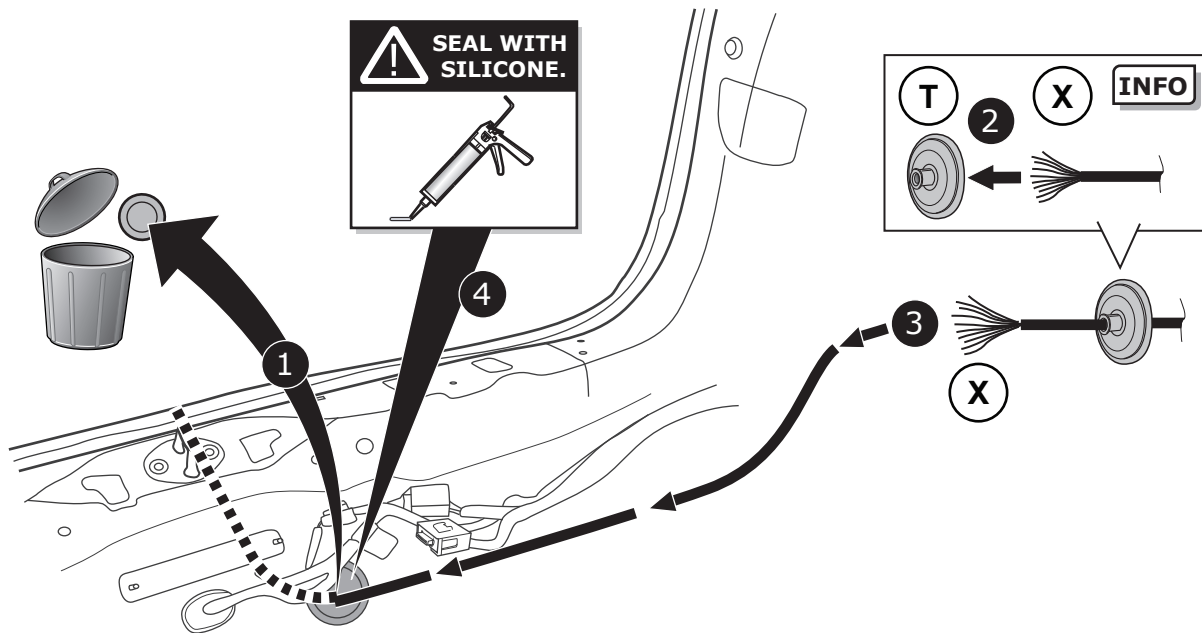
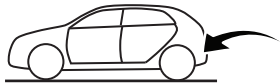

Fig 5



Option 2: 2017 - models

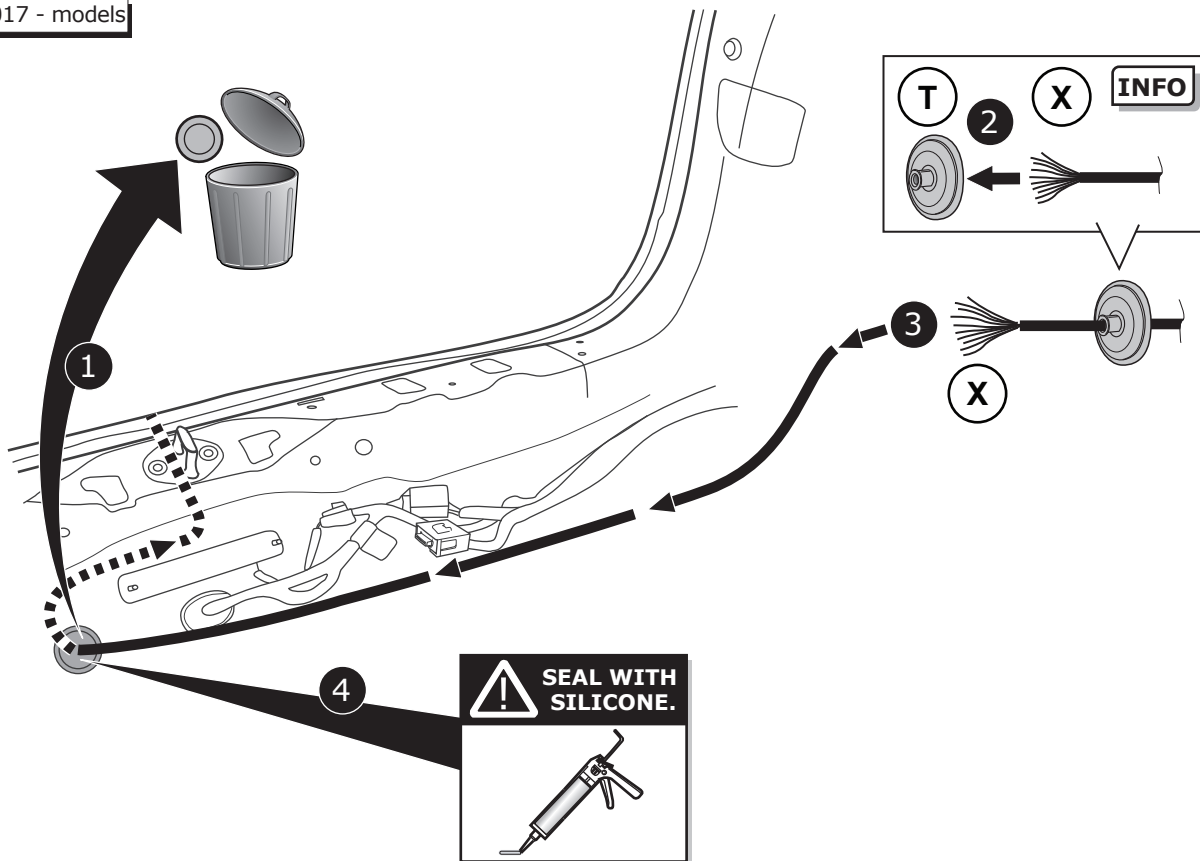
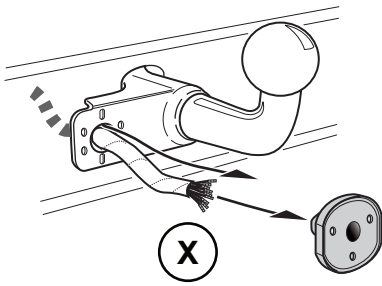
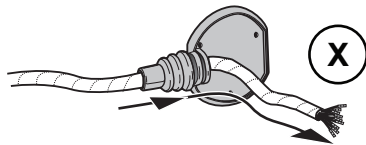

Fig 6

Option 1



Option 2



Option 3

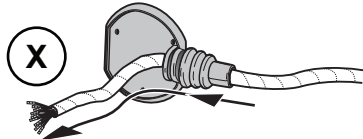

Fig A

- ⒹE Anschluss Steckdose
- ⒻR Connection de la prise
- ⒹL Contactdoos aansluiting
- ⒼB Socket connection
- ⒺS Conexión de la caja de enchufe
- ⒾT Allaccio zoccolo
- ⒺE Anslutning kontaktdosa
- ⒸZ Objímkový konektor
- ⒹK Stikdåse forbindelse
- ⒻI Pistorasia liitântä
- ⒼR Υποδοχή σύνδεσης
- ⒹO Tilkobling koblingsboks
- ⒼL Połączenie przez gniazdo
- ⒹU Подключение розетки
- ⒺK Pripojenie k zásuvke
- ⒹO Conexiune socket



Pag. 17

INFO

Option 1

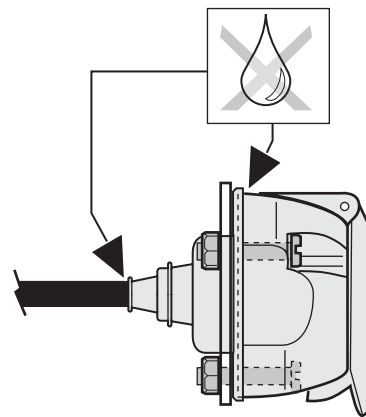
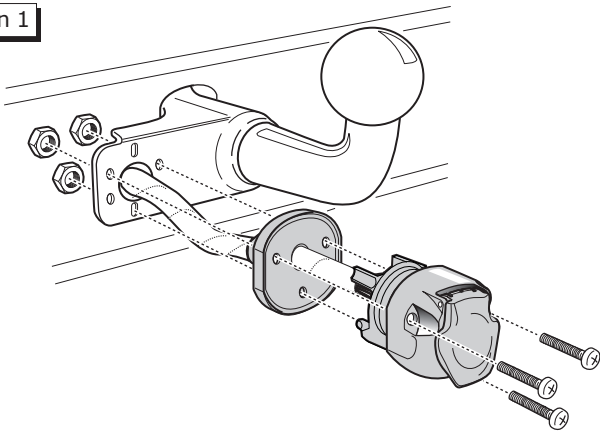

Fig B

Option 2

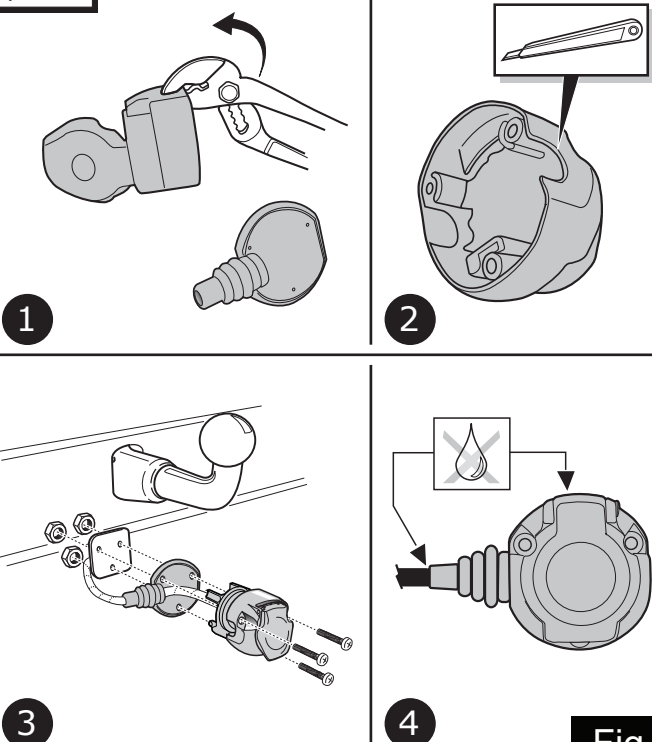

Fig C

Option 3

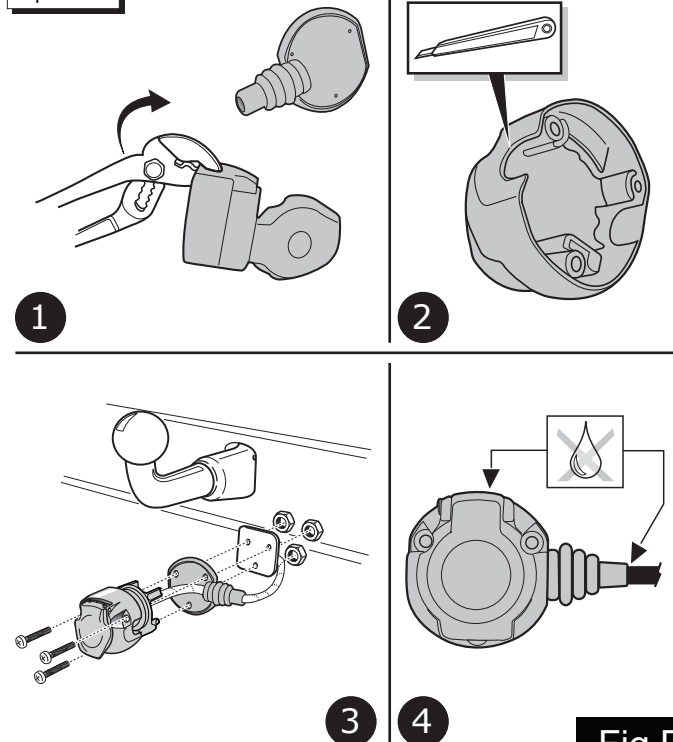
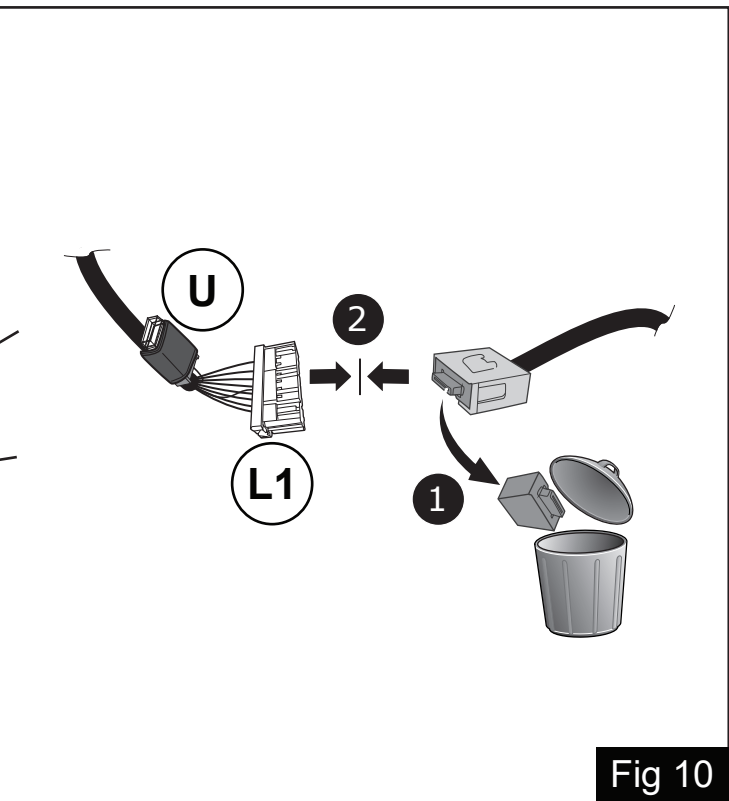
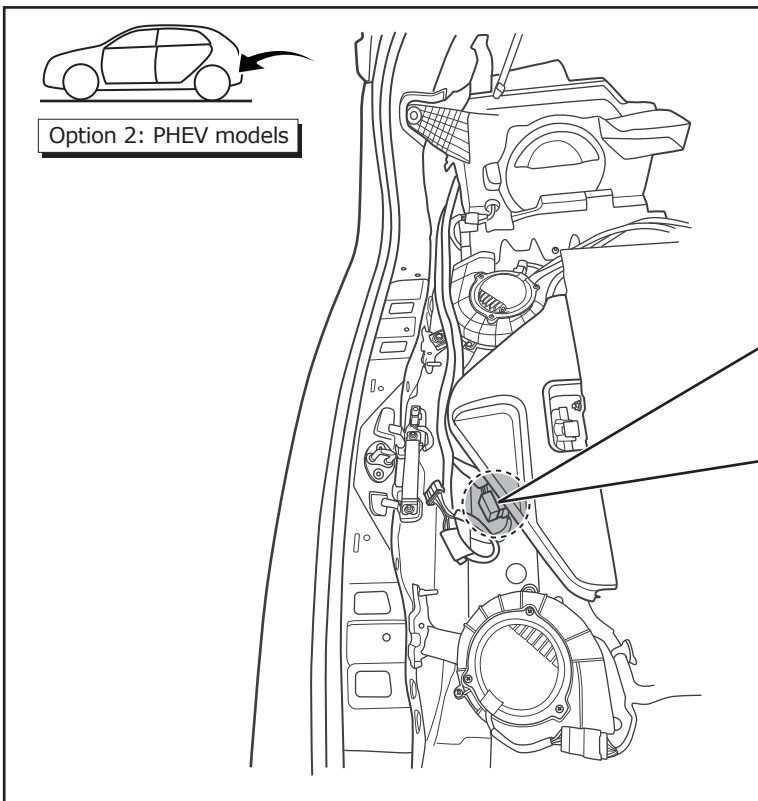
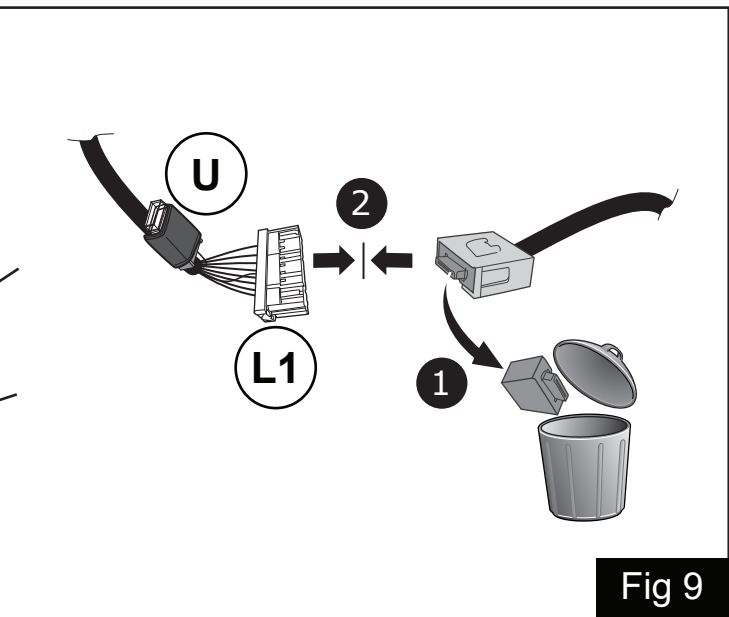
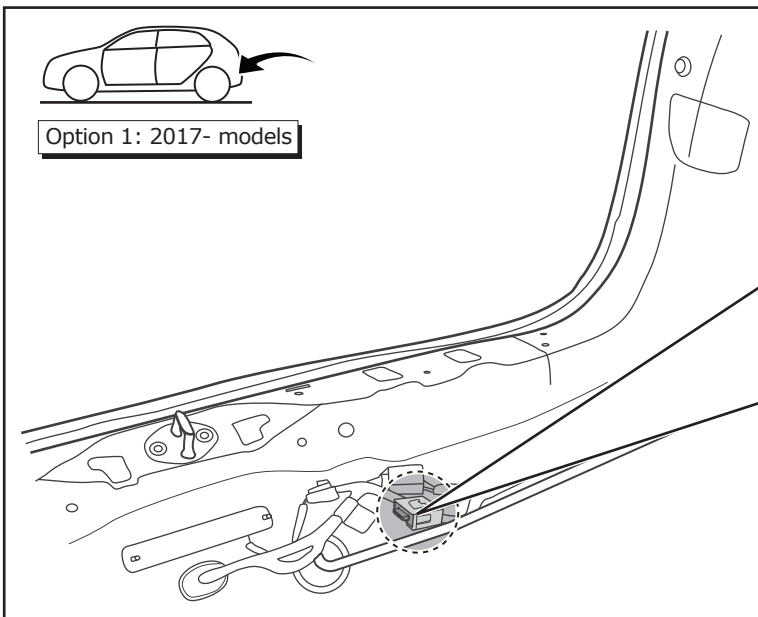
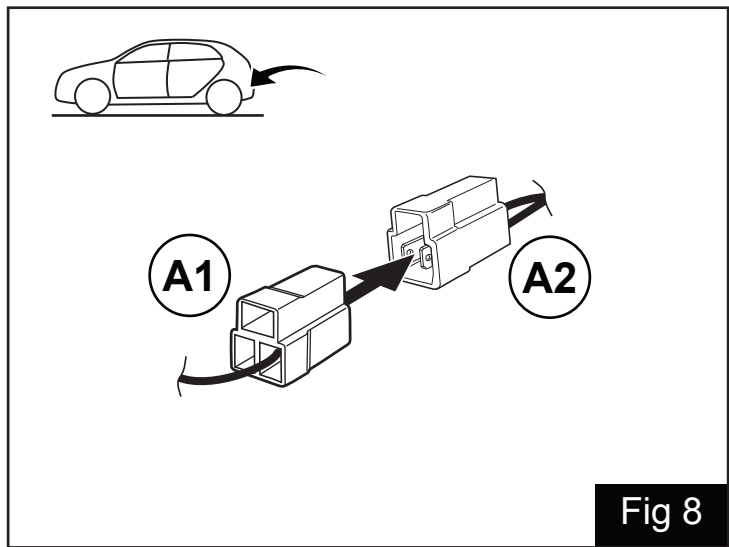
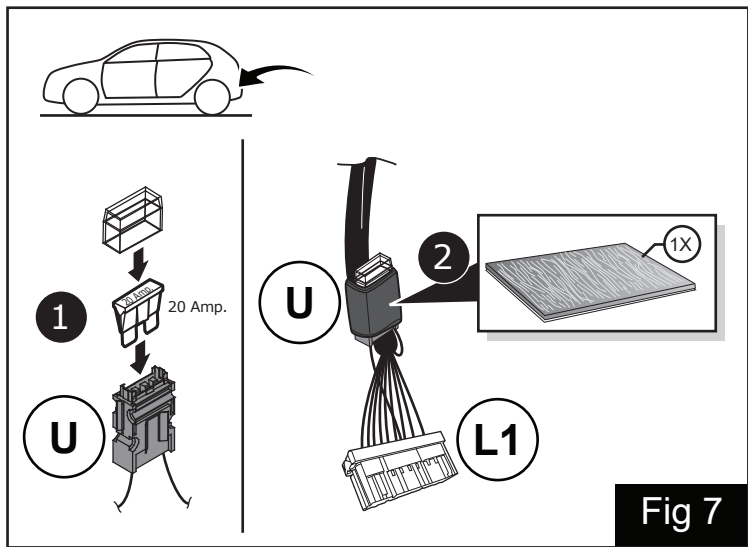
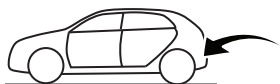

Fig D





Option 1: 2017- models

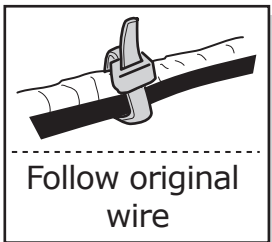
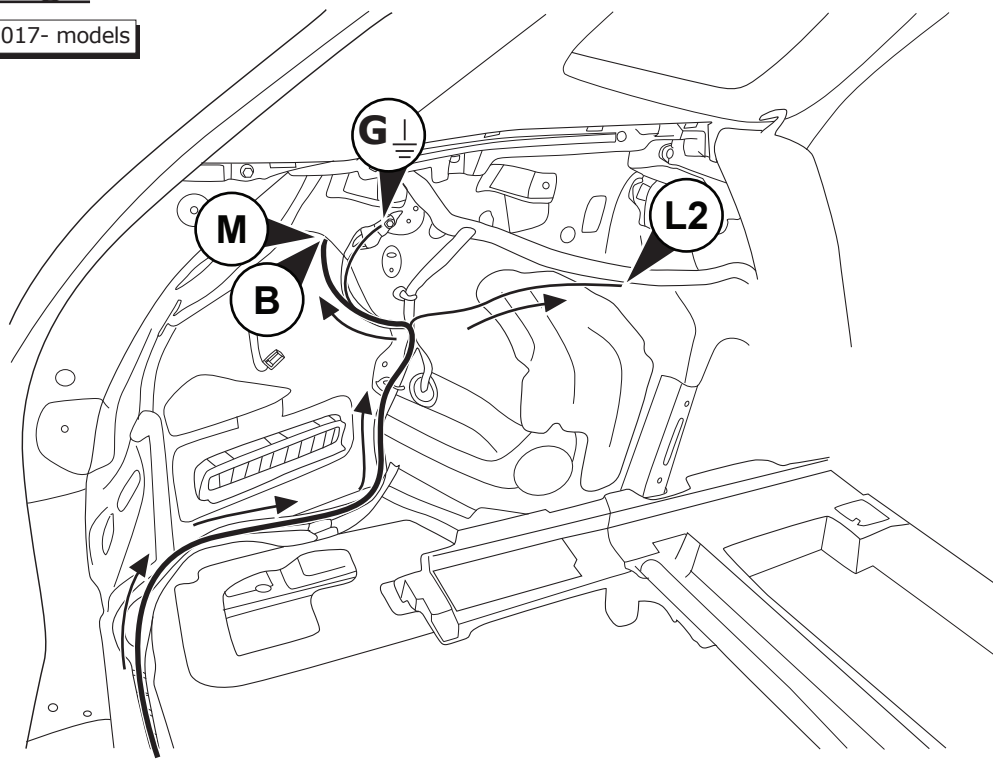

Fig 11



Option 2: PHEV models

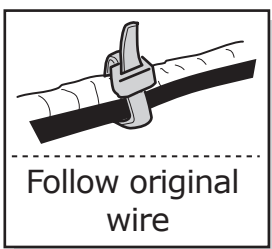
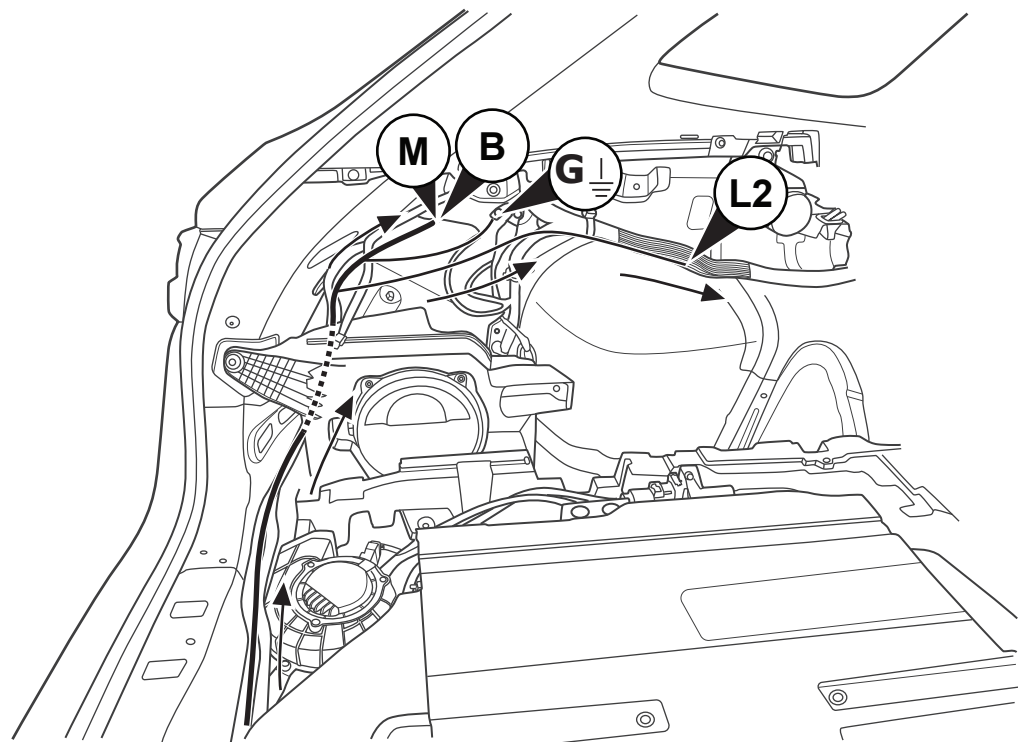

Fig 12

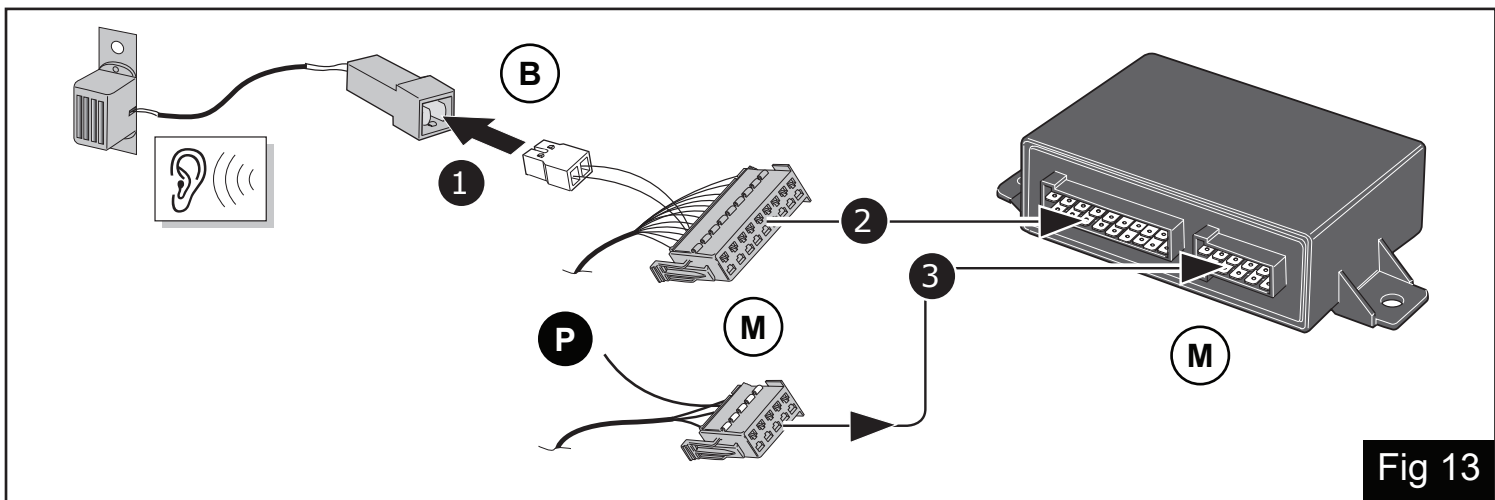

Fig 13

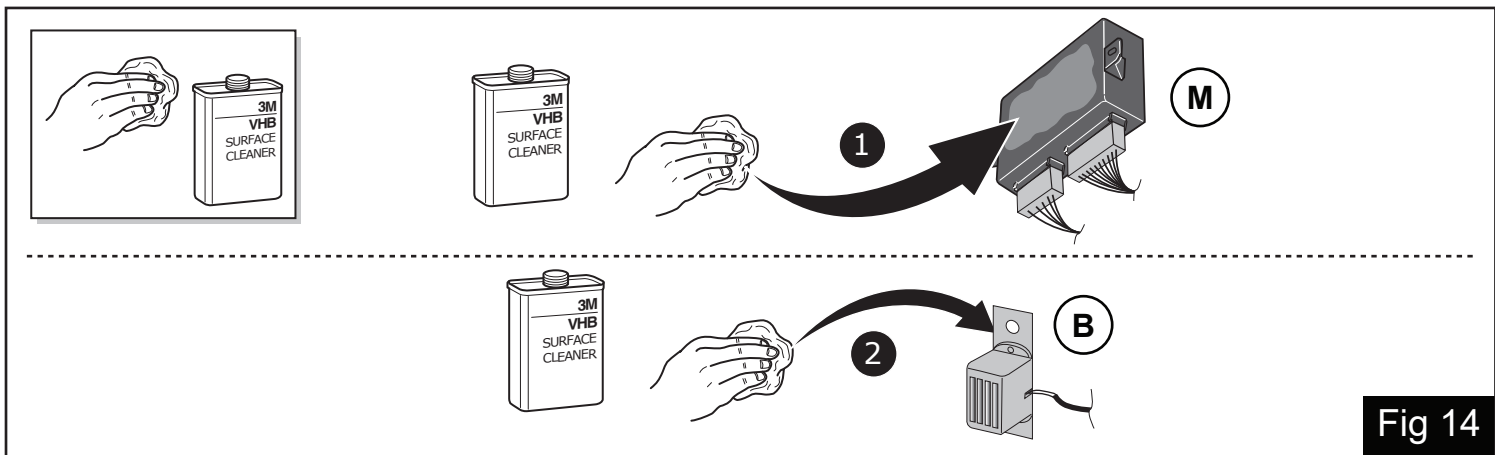

Fig 14

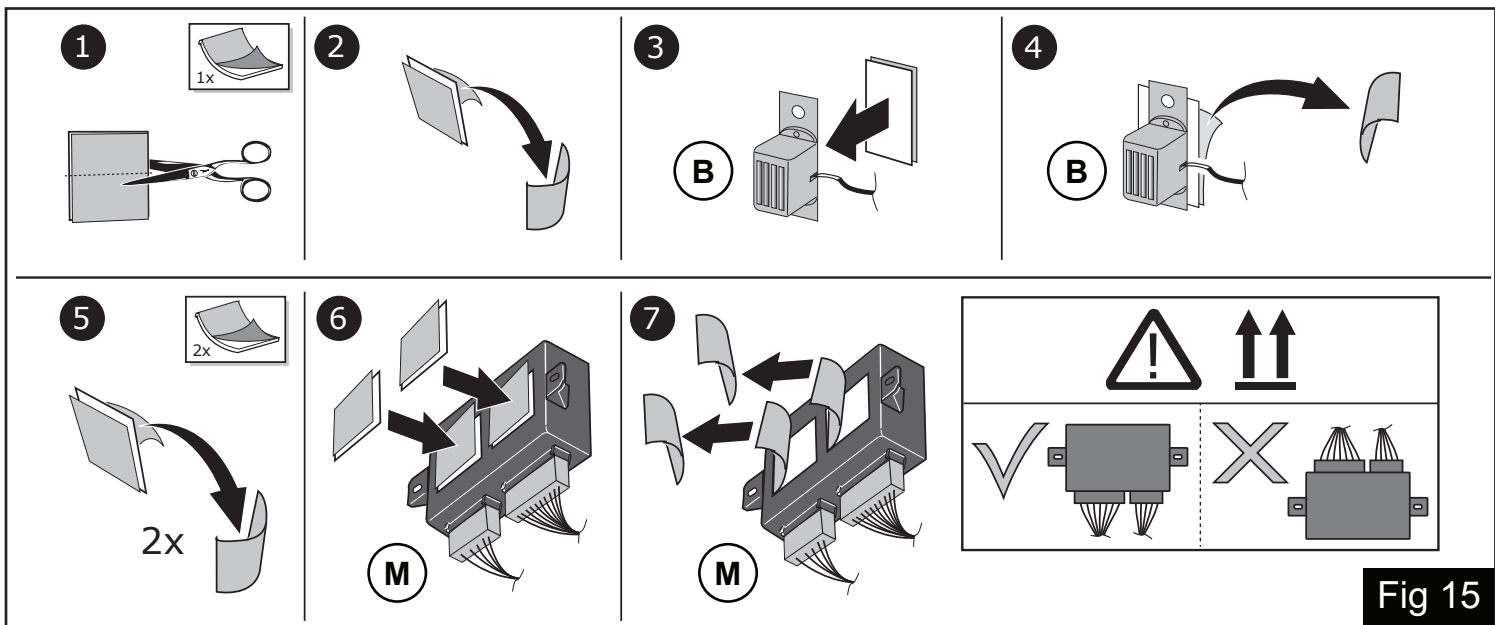

Fig 15

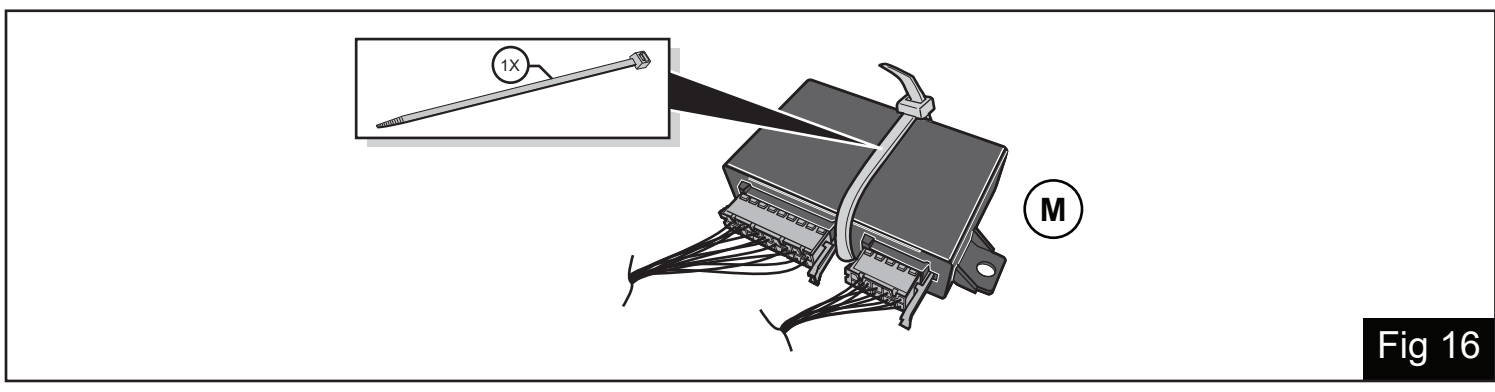
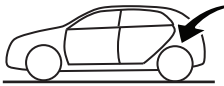

Fig 16



- | | |
|----------------------------------|-----------------------------------|
| (DE) Klebeband entfernen | (DK) Aftag tapen |
| (FR) Enlevez Ruban adhésif | (FI) Poista teippi |
| (NL) Tape verwijderen | (GR) Αφαιρέστε την ταινία |
| (GB) Remove tape | (NO) Fjern limbåndet |
| (ES) Retirar la cinta adhesiva | (PL) Zdjąć taśmę |
| (IT) Rimuovere il nastro adesivo | (RU) Удаление ленты |
| (SE) Avlägsna klisterbandet | (SK) Odstráňte pásku |
| (CZ) Odstraňte pásku | (RO) Îndepărtați banda izolatoare |

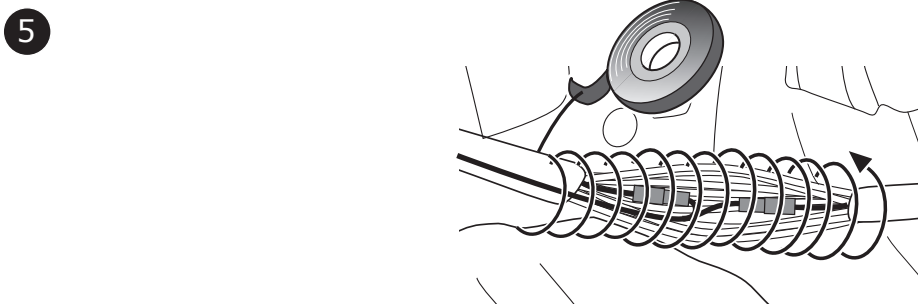
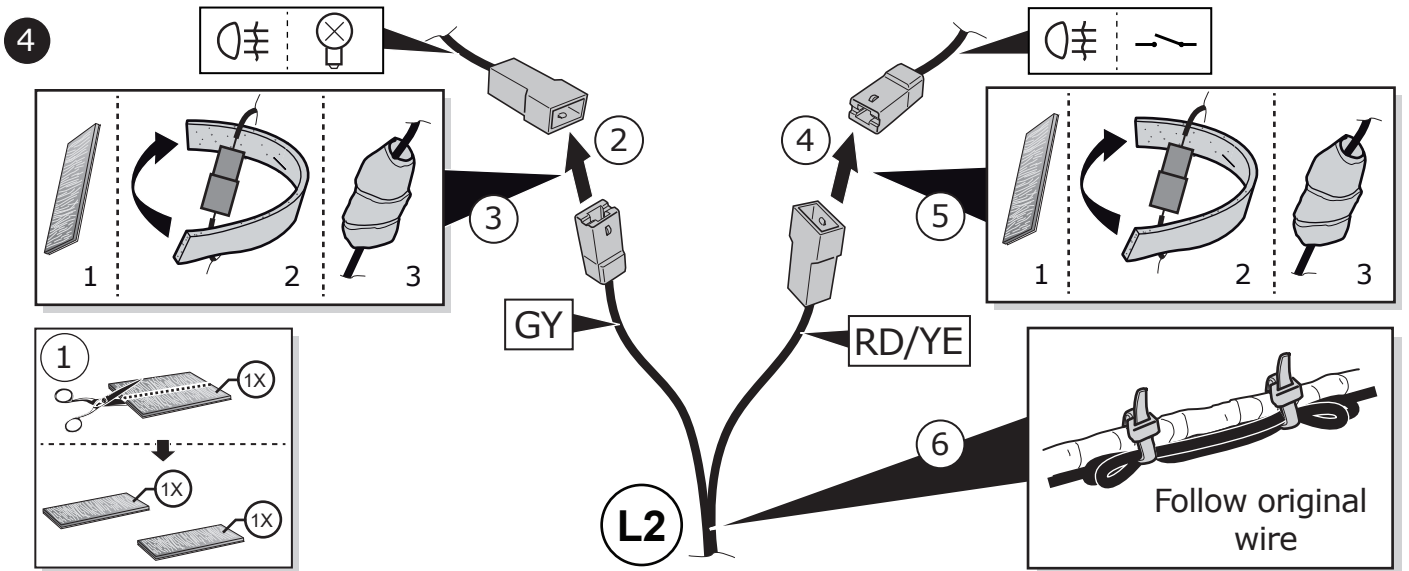
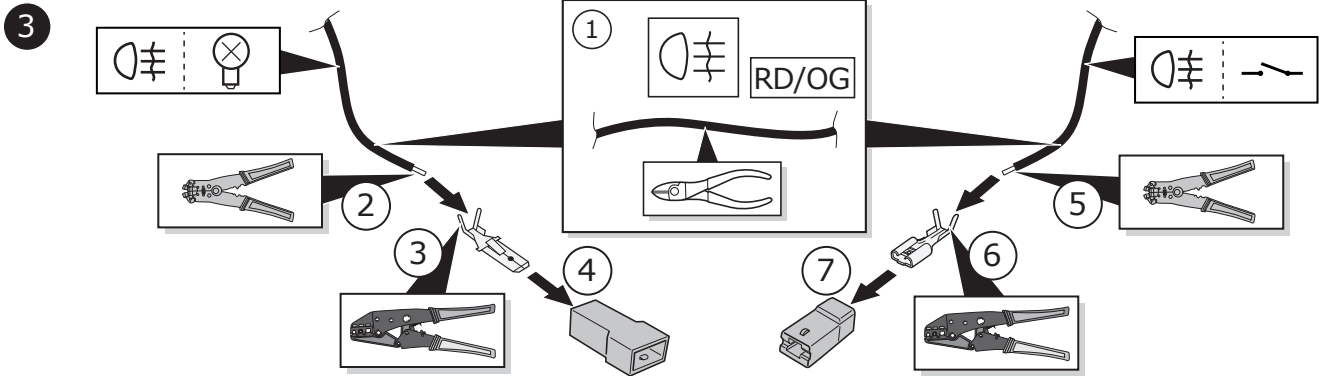
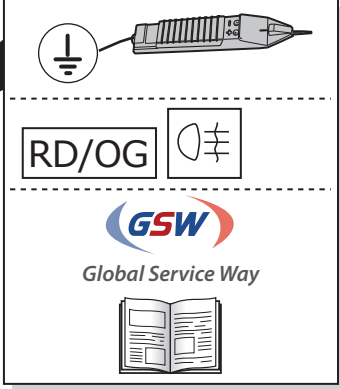
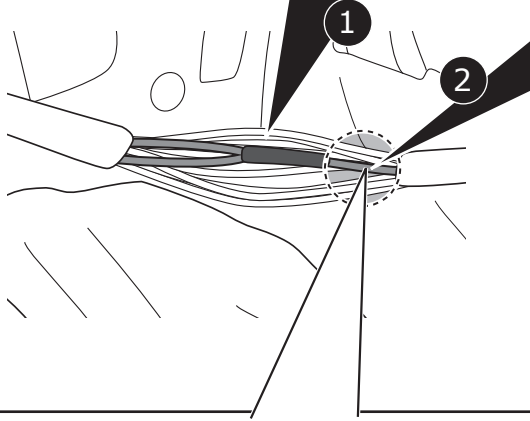
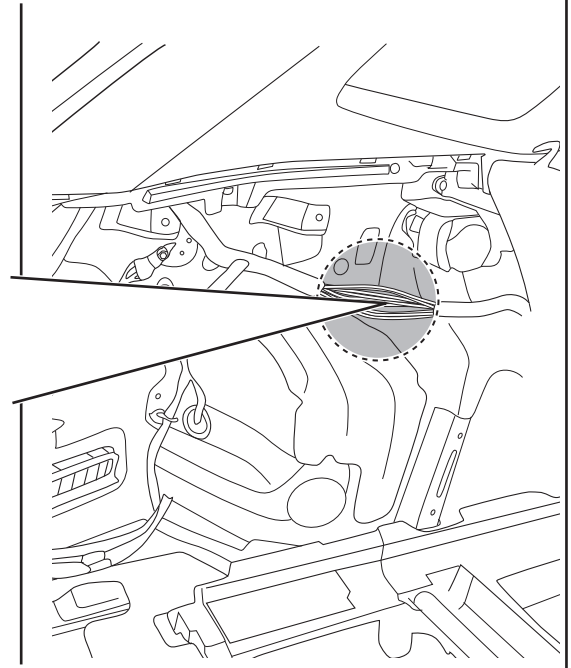

Fig 19

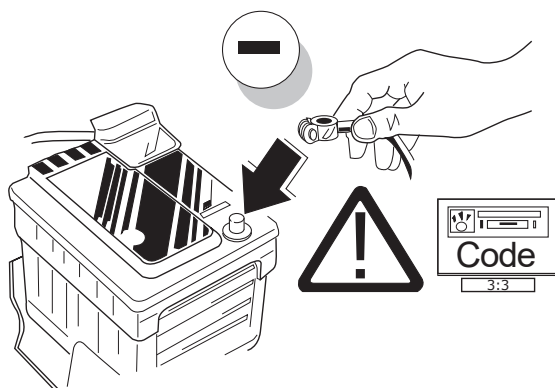
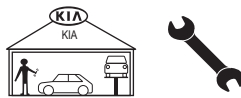

Fig 20

DE FUNKTIONEN KONTROLLIEREN MIT EINEM PRÜFGERÄT MIT WIDERSTAND ODER MIT LEUCHTEN MIT DER GENAUEN WATTZAHL!

FR CONTRÔLER LES FONCTIONS AVEC UNE BOÎTE DE TEST AVEC DE LA CHARGE OU DES LAMPES AVEC LA QUANTITÉ CORRECTE DE WATT!

NL CONTROLEER FUNCTIES MET EEN TESTER MET BELASTING OF LAMPEN MET DE JUISTE WATTAGE!

GB TEST ALL CIRCUIT FUNCTIONS WITH A TESTBOX WITH THE CORRECT POWER LOAD FOR EACH UNIT. A TESTBOX ON WHICH ONLY LEDs ARE USED CAN NOT BE USED IN THIS CASE

ES ¡CONTROLAR FUNCIONES CON UN TESTER CON CARGA O LUCES CON EL CORRECTO WATTAJE!

IT CONTROLLA FUNZIONI CON UN TESTER CON CARICO O LAMPAD E DEL GIUSTO WATT-TAGGIO!

SE KONTROLLERA FUNKTIONERNA MED EN TESTARE MED BELASTNING ELLER LAMPOR MED RÄTT WATT-VÄRDE!

RO TESTA TOATE FUNCȚIILE DE CIRCUIT CU O CUTIE DE TESTARE CU SARCINA DE ALIMENTARE CORECT PENTRU FIECARE UNITATE. O CUTIE DE TESTARE CU LĂMPI CU LED NUMAI CĂ NU POATE FI UTILIZAT ÎN ACEST CAZ

CZ OVĚŘTE FUNKCE POMOCÍ TESTOVACÍHO BOXU NEBO SVĚTEL S PŘÍSLUŠNÝM VÝKONEM!

DK CHECK FUNKTIONERNE MED EN TESTBOKS, MED BELASTNING ELLER MED LYGTER MED DET KORREKTE ANTAL WATT!

FI TARKISTA TOIMINNOT KÄYTTÄMÄLLÄ TESTILAITE, JOSSA ON OIKEATEHOINEN KUORMITUS TAI OIKEATEHOISET LAMPUT!

GR ΕΛΕΓΞΤΕ ΤΙΣ ΛΕΙΤΟΥΡΓΙΕΣ ΜΕ ΉΝΑ ΚΙΒΩΤΙΟ ΔΟΚΙΜΗΣ ΜΕ ΦΟΡΤΙΟ Ή ΛΑΜΠΗΡΕΣ ΣΩΣΤΗΣ ΠΟΣΟΤΗΤΑΣ ΒΑΤ!

NO KONTROLER FUNKSJONENE MED EN TESTER MED BELASTNING ELLER LYSPÆRER MED RIKTIG WATTVERDI!

PL SPRAWDŹ FUNKCJE UŻYWAJĄC SKRZYŃKI TESTOWEJ Z OBCIĄŻENIEM LUB PODŁĄCZONYMI ŻARÓWKAMI O ODPOWIEDNIEJ MOCY!

RU ПРОВЕРТЕ РАБОТУ ФУНКЦИЙ С ПОМОЩЬЮ ИСПЫТАТЕЛЬНОГО ПРИБОРА ЭЛЕКТРИЧЕСКОЙ НАГРУЗКОЙ ИЛИ С ЛАМПАМИ С СООТВЕТСТВУЮЩЕЙ МОЩНОСТЬЮ (ВАТТ)!

SK PREVERTE FUNKCIE SKÚŠAČKOU SO ZAŤAŽENÍM ALEBO ŽIAROVKOU SO SPRÁVNÝM PRÍKONOM!

Fig 21

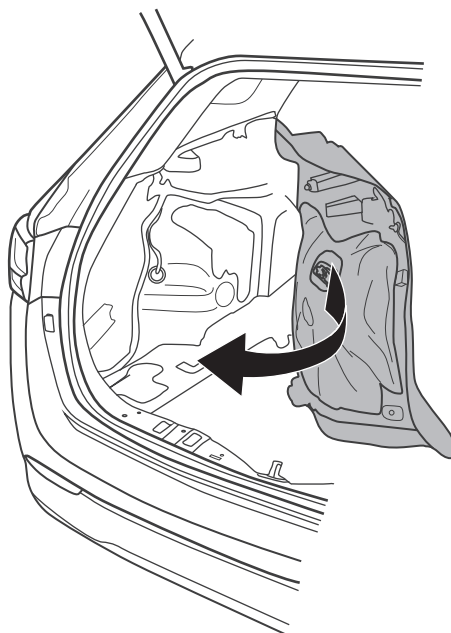
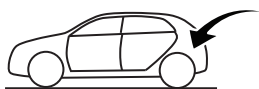

Fig 22

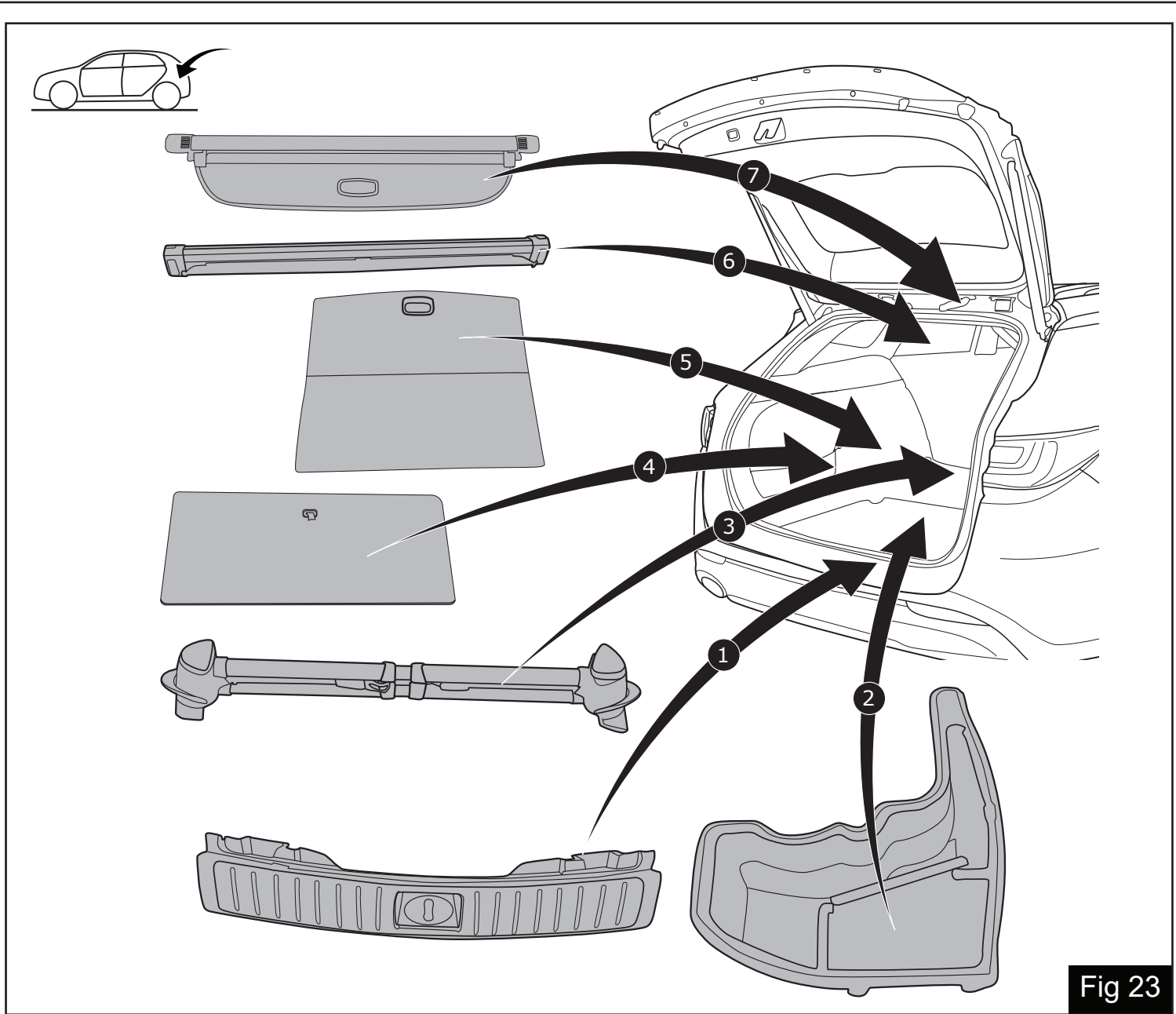
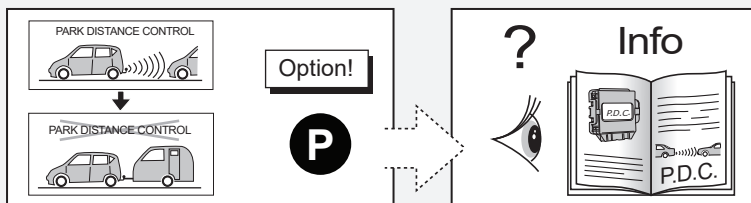
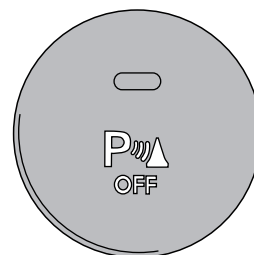
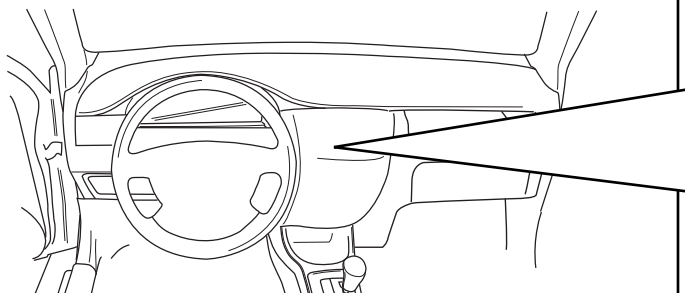
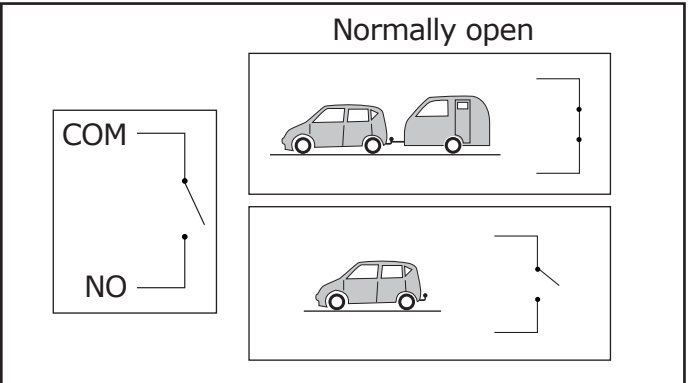
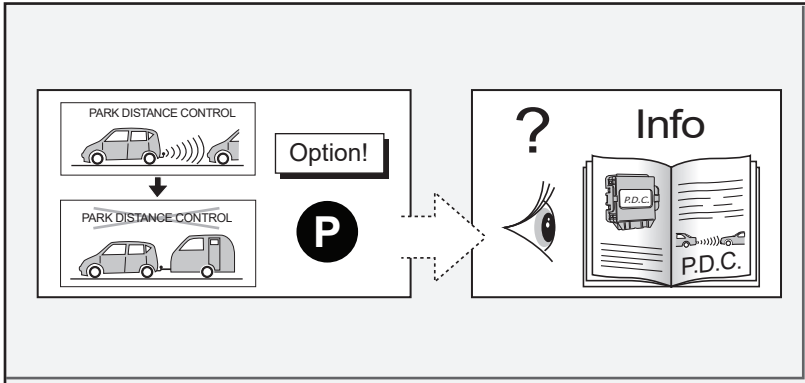

Fig 23



Option 1 For OEM installed PDC systems





Option 2 For KIA Accessory PDC systems only (Cobra Systems)

1

- | | |
|------------|-----------|
| DE Schwarz | DK Sort |
| FR Noir | FI Musta |
| NL Zwart | GR Μαύρο |
| GB Black | NO Svart |
| ES Negro | PL Czarny |
| IT Nero | RU черный |
| SE Svart | SK Čierna |
| CZ Černá | RO Negru |

- | | |
|----------|--------------|
| DE Blau | DK Blå |
| FR Blue | FI Sininen |
| NL Blauw | GR Μπλε |
| GB Blue | NO Blå |
| ES Azul | PL Niebieski |
| IT Blu | RU синий |
| SE Blå | SK Modrá |
| CZ Modrá | RO Albastru |

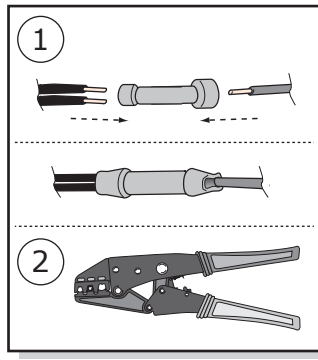
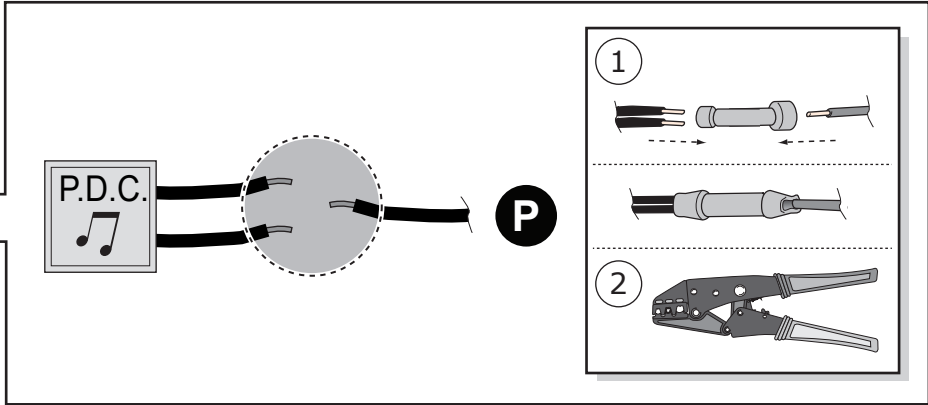
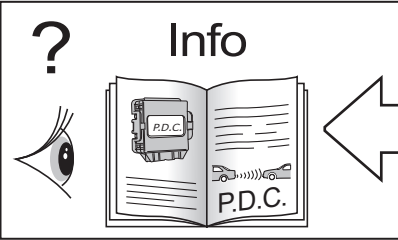
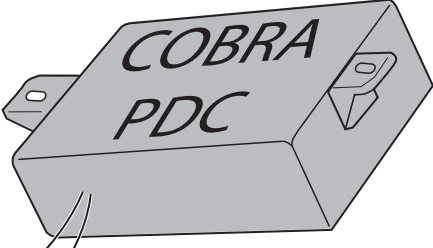

2

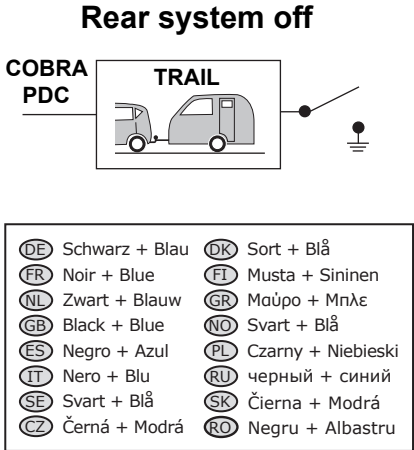
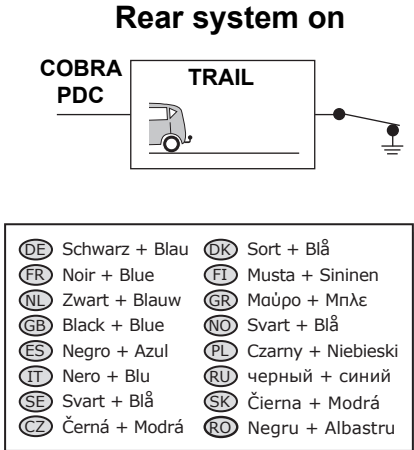
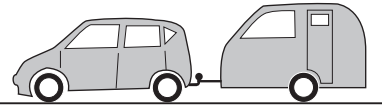

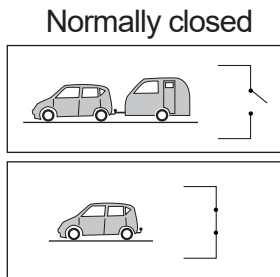
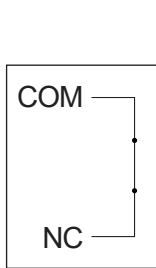
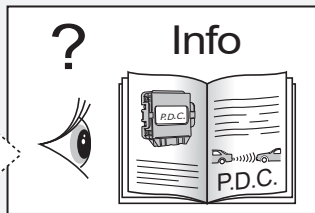
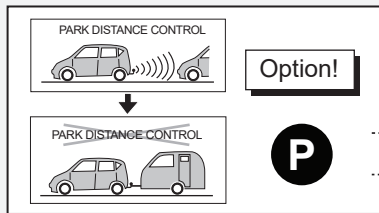

Option 3 For aftermarket installed PDC systems

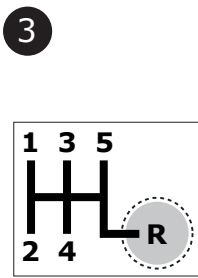
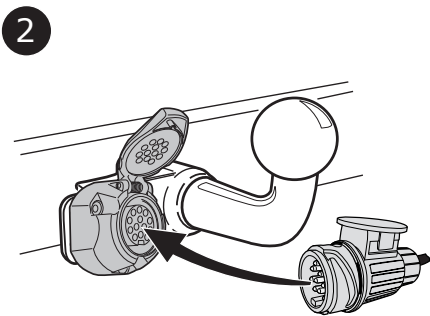
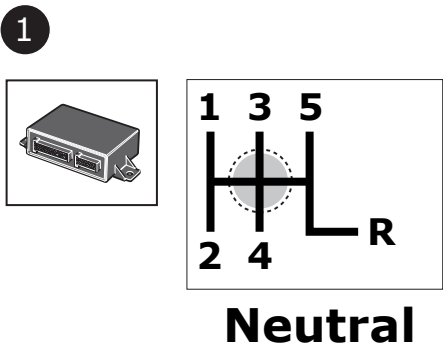
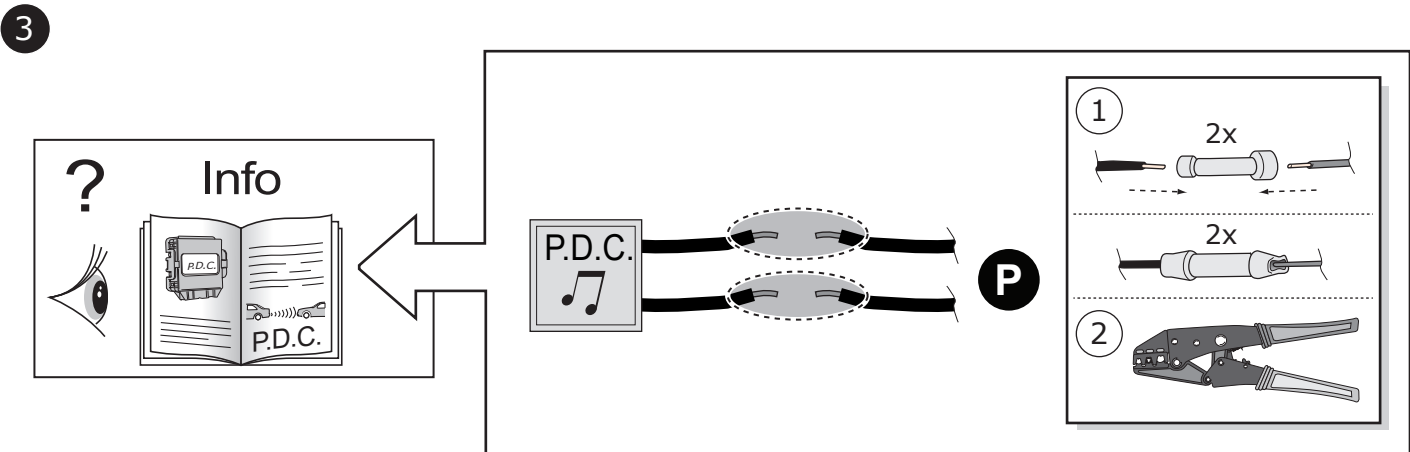
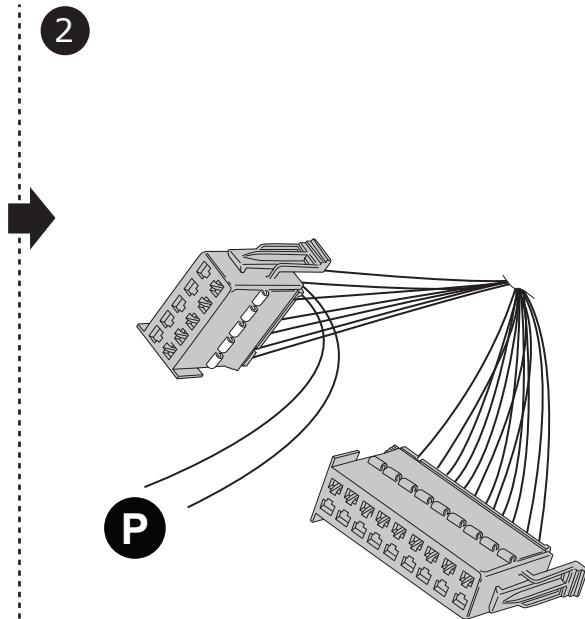
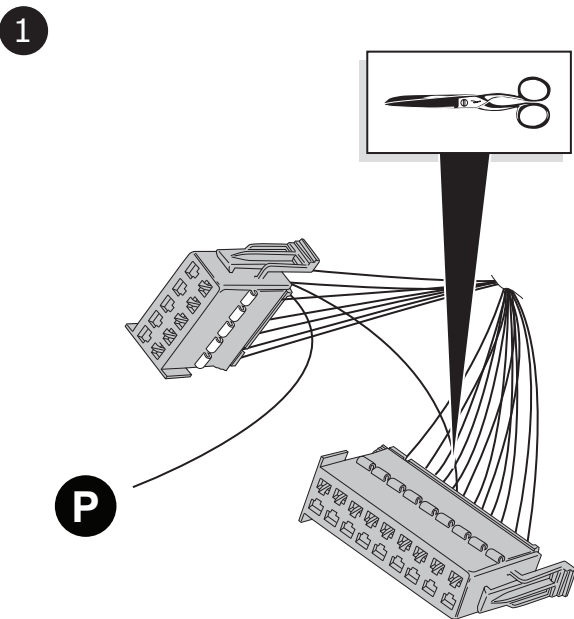

4

TEST

