

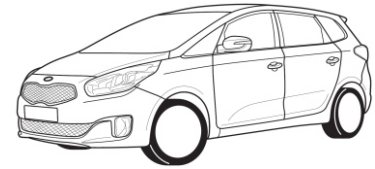

KIA MOTORS

# INSTALLATION INSTRUCTION



20 Minutes

KIA Carens MY 2013-

Part no. A4450ADE00

- DE** Einbauhinweise
- FR** Instructions de montage
- NL** Installatie-instructies
- GB** Installation instructions
- ES** Instrucciones de montaje
- IT** Istruzioni di montaggio
- SE** Monteringsinstruktioner
- SK** Návod na montáž

- CZ** Návod na montáž
- DK** Monteringsvejledning
- FI** Sumuvalosarjan
- GR** Οδηγίες τοποθέτησης
- NO** Monteringsanvisning
- PL** Instrukcja montażu
- RU** Инструкция по установке

## PRE-INSTALLATION CAUTIONS/NOTES

- |  |   |
|--|---|
| <p><b>DE</b> Beachten Sie bitte, dass bei Schäden in Folge unsachgemäßen Einbaus sämtliche Garantieansprüche erlöschen, insbesondere solche, die das Produkthaftungsgesetz betreffen.</p> <p><b>FR</b> Nous tenons à insister tout particulièrement sur le fait que si ce produit n'est pas correctement assemblé par un technicien compétent, aucun droit de compensation ne sera recevable en cas de dommages, notamment les droits en vertu de la loi concernant la responsabilité à l'égard des produits.</p> <p><b>NL</b> We benadrukken dat incorrecte installatie kan leiden tot het vervallen van elk recht op schadecompensatie, met name die met betrekking tot productaansprakelijkheid.</p> <p><b>GB</b> We expressly point out that assembly not carried out properly by a competent installer will result in cancellation of any right to damage compensation, in particular those arising by virtue of the product liability act.</p> <p><b>ES</b> Una vez más, hacemos hincapié en el hecho de que si este producto no lo monta correctamente un técnico instalador cualificado, se anulará cualquier derecho de compensación por posibles daños, especialmente los relativos a la legislación vigente sobre este tipo de productos.</p> <p><b>IT</b> Si prega di notare che, in caso di installazione scorretta non eseguita da un installatore competente, l'utente perderà ogni diritto a un eventuale rimborso danni e, specificamente, ogni diritto previsto dalle leggi sulla responsabilità di prodotto.</p> <p><b>SE</b> Vi meddelar att montering, som inte görs fackmannamässigt, kommer att häva rätten till kompensation för skador, speciellt rättigheter enligt lagen om produktansvar.</p> <p><b>CZ</b> Upozorňujeme, že instalace provedená nesprávně nebo nekompetentní osobou, ruší veškerá práva na kompenzaci škod, obzvláště způsobených poruchou produktu.</p> <p><b>DK</b> Det skal understreges, at montering, der udføres af en ikke-kvalificeret montør, medfører bortfald af enhver ret til erstatning særligt i forbindelse med erstatningskrav, der måtte opstå i kraft af loven om produktansvar.</p> <p><b>FI</b> Jos asennuksen suorittaa joku muu kuin pätevä ammattilainen, tämä kumooa asiakkään oikeuden vahingonkorvauksiin, erityisesti sellaisiin, jotka perustuvat tuotevastuulakiin.</p> <p><b>GR</b> Θα πρέπει να τονιστεί ότι συναρμολόγηση που δεν πραγματοποιείται σωστά και από ειδικευμένο εγκαταστάτη οδηγεί σε ακύρωση των όποιων δικαιωμάτων αποζημίωσης έναντι ζημίας και ιδιαίτερα αυτών που προκύπτουν σύμφωνα με το νόμο περί ευθύνης προϊόντος.</p> <p><b>NO</b> Vi bemerker at montasje som ikke utføres korrekt, av en kompetent installatør, vil resultere i annullering av all rett til erstatning for enhver skade, spesielt de som oppstår av arten produktansvar.</p> <p><b>PL</b> 'Pragniemy zwrócić uwagę na fakt, że nieprawidłowy montaż przeprowadzony przez niekompetentne osoby będzie podstawą do unieważnienia wszelkich praw do odszkodowań, w szczególności wynikających z ustaw o odpowiedzialności za produkt.</p> <p><b>RU</b> Обратите при повреждениях, возникших в результате неправильного монтажа, истекают все виды гарантии, в частности, касающиеся закона, регулирующего ответственность за качество продукции.</p> <p><b>SK</b> Upozorňujeme, že inštalácia vykonaná nesprávne alebo nekompetentnou osobou, ruší všetky práva na kompenzáciu škôd, obzvlášť spôsobených poruchou produktu.</p> | <p>Das Recht zu Änderungen an Inhalt von Montagesatz und Einbauanleitung ohne Vorankündigung bleibt vorbehalten. Lesen Sie vor dem Einbau diese Anleitung sorgfältig durch.</p> <p>Le contenu de ces kits, ainsi que des guides de montage qui les accompagnent est sujet à modifications sans préavis ; lisez attentivement ces instructions avant de procéder à l'installation.</p> <p>De inhoud van deze kits en de installatiehandleidingen kunnen worden gewijzigd zonder kennisgeving. Zorg er voor dat u deze instructies hebt gelezen en volledig begrijpt voordat u met de installatie begint.</p> <p>Contents of these kits and their fitting manuals are subject to alteration without notice, please ensure that these instructions are read and fully understood before commencing installation.</p> <p>El contenido de los kits y sus correspondientes manuales de montaje están sujetos a posibles modificaciones sin previo aviso. Es importante que lea con atención todas las instrucciones y que las entienda perfectamente antes de iniciar la instalación.</p> <p>I contenuti di questi kit e i relativi manuali di installazione sono soggetti a modifica senza preavviso. Si raccomanda di leggere attentamente e integralmente tali istruzioni e di sincerarsi di averle comprese prima di procedere all'installazione.</p> <p>Innehållet i dessa satser och deras bruksanvisningar kan komma att ändras utan föregående meddelande. Vänligen läs dessa anvisningar noga innan du påbörjar monteringen.</p> <p>Obsah těchto sad a návody na jejich montáž podléhají změnám bez předchozího upozornění. Prosím, ujistěte se, že jste si pokyny před instalací přečetli a dostatečně jim rozumíte.</p> <p>Sættenes indhold og monteringsvejledninger kan ændres uden varsel, og vejledningerne skal derfor læses og forstås, før monteringen påbegyndes.</p> <p>Kiinnityssarjan sisältöä ja asennusoppaita voidaan muuttaa siitä etukäteen ilmoittamatta. Asiakkään tulee ennen asennuksen aloittamista perehtyä huolellisesti näihin ohjeisiin.</p> <p>Τα περιεχόμενα αυτών των kit και τα εγχειρίδια τοποθέτησης υπόκεινται σε αλλαγές χωρίς προειδοποίηση. Βεβαιωθείτε ότι ο οδηγός αυτές έχουν Α:ΒCδιαβάσει και έχουν γίνει απολύτως κατανοητές προτού ξεκινήσετε την εγκατάσταση.</p> <p>Innholdene i disse sett og deres monteringsanvisninger kan endres uten forvarsel. Vennligst påse at disse instruksjonene leses grundig og er forstått innen installasjonen startes.</p> <p>Zawartość opisywanych zestawów i instrukcje ich montażu mogą ulegać zmianom bez powiadomienia; przed rozpoczęciem instalacji należy zapoznać się z instrukcjami i upewnić się, że zostały zrozumiane.</p> <p>Право изменения содержания монтажного комплекта и инструкции по установке без предварительного оповещения производитель оставляет за собой. Внимательно прочитайте инструкцию перед тем, как начать установку.</p> <p>Obsah týchto sad a návody na ich montáž podliehajú zmenám bez predchádzajúceho upozornenia. Prosím, uistite sa, že ste si pokyny pred inštaláciou prečítali a dostatočne ste im porozumeli.</p> |
|--|---|

# INSTALLATION INSTRUCTION

- Einzelteile  
DE
- Liste de pieces  
FR
- Onderdelenlijst  
NL
- Part list  
GB
- Lista de componentes  
ES
- Elenco componenti  
IT
- Dellista  
SE
- Jednotlivé díly  
CZ
- Del-liste  
DK
- Osaluettelo  
FI
- Επιμέρους εξαρτήματα  
GR
- Delliste  
NO
- Wykaz części  
PL
- Перечень деталей  
RU
- Položiek díelov  
SK

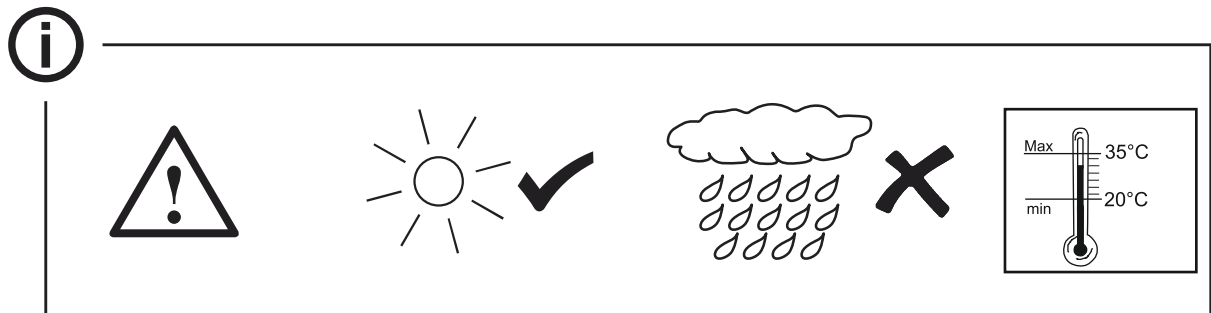
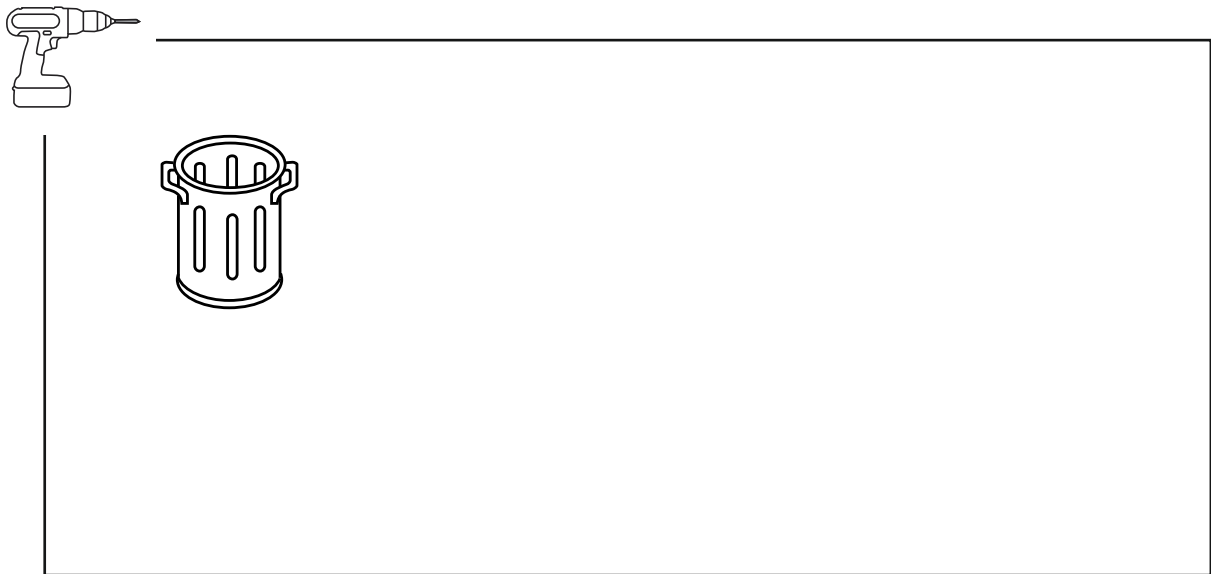
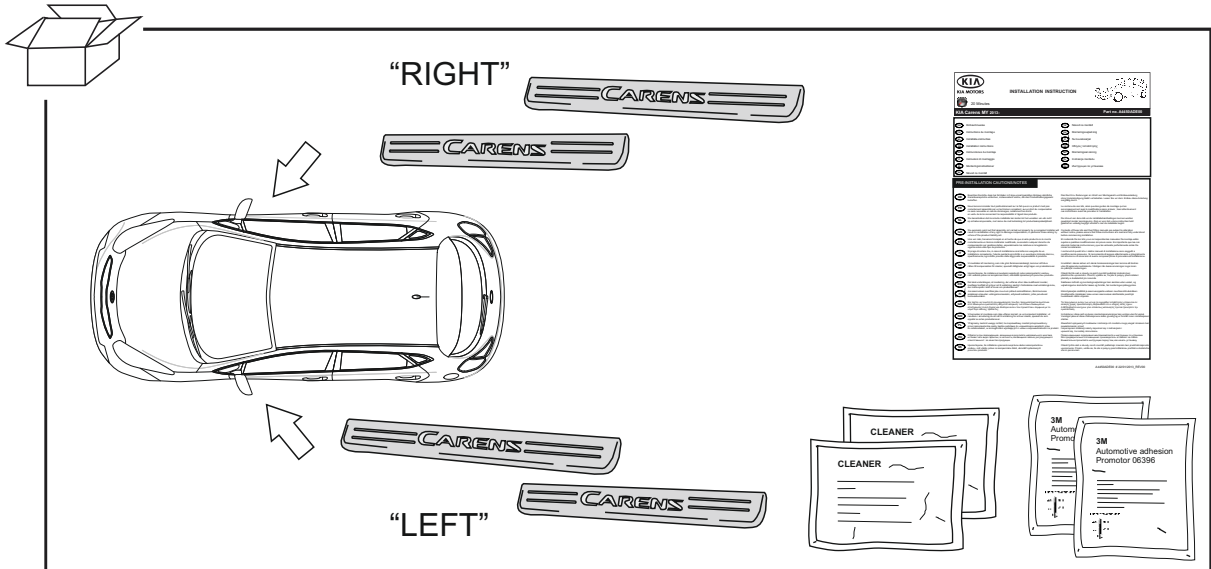

# INSTALLATION INSTRUCTION

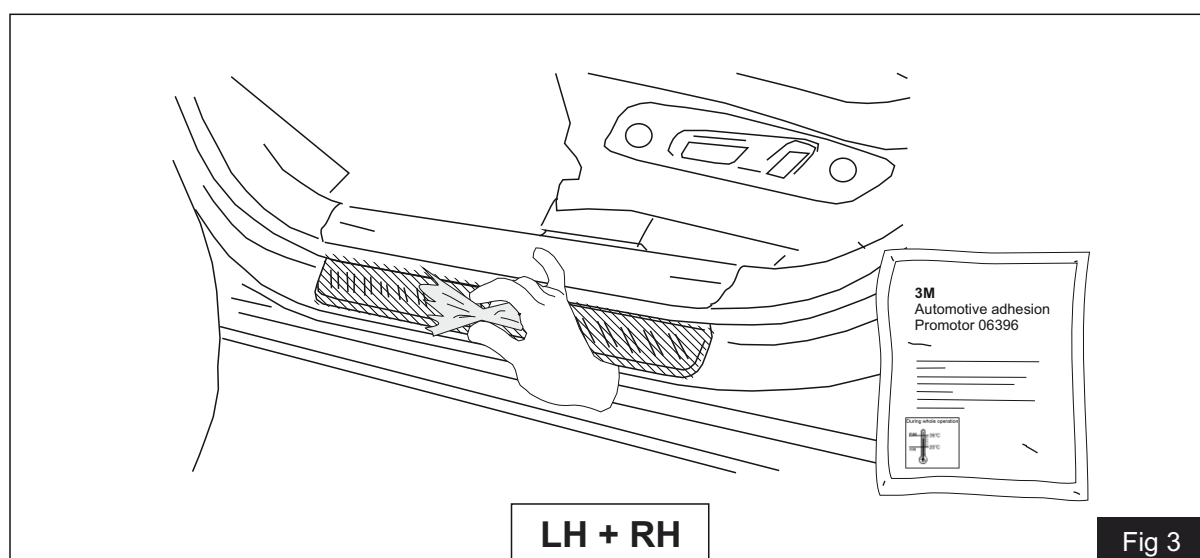
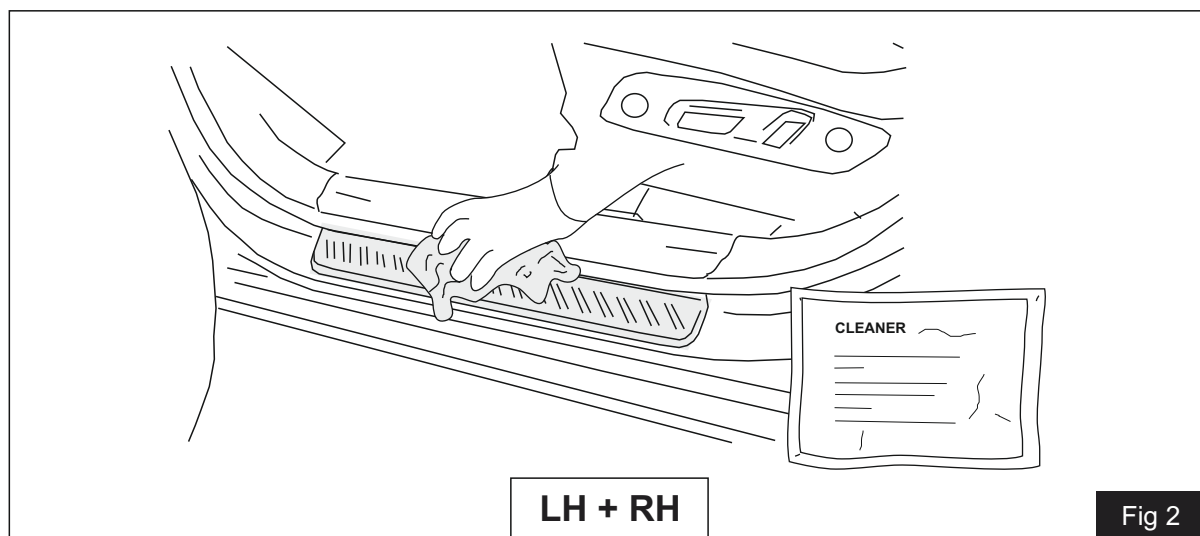
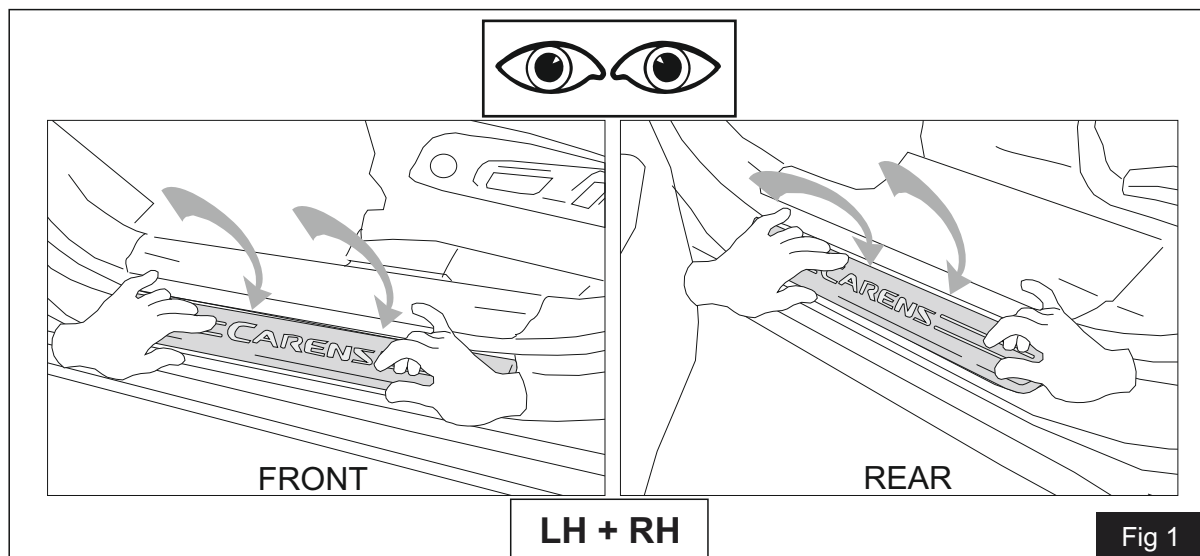

# INSTALLATION INSTRUCTION

